







Abbinamento dispositivi modulari e placche

Placche		Dispositivi modulari							
		Comandi tradizionali	Pulsanti soft click	Moduli assiali EVO	Moduli assiali CONNESSI	Prese / altri frutti	Moduli comando touch		
							Tradizionali	KNX	
ONE		✓	✓	✓	✓	✓	-	-	
GEO		✓	✓	✓	✓	✓	-	-	
EGO		✓	✓	✓	✓	✓	-	-	
EGO SMART		✓	✓	✓	✓	✓	-	-	
LUX		✓	✓	✓	✓	✓	-	-	
ICE	ICE		✓	✓	✓	✓	✓	-	-
	ICE Touch		-	-	-	-	-	✓	-
	ICE Touch KNX		-	-	-	-	-	-	✓

ChoruSmart - serie civile

Tablee dimensionali

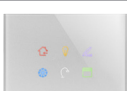
SUPPORTI

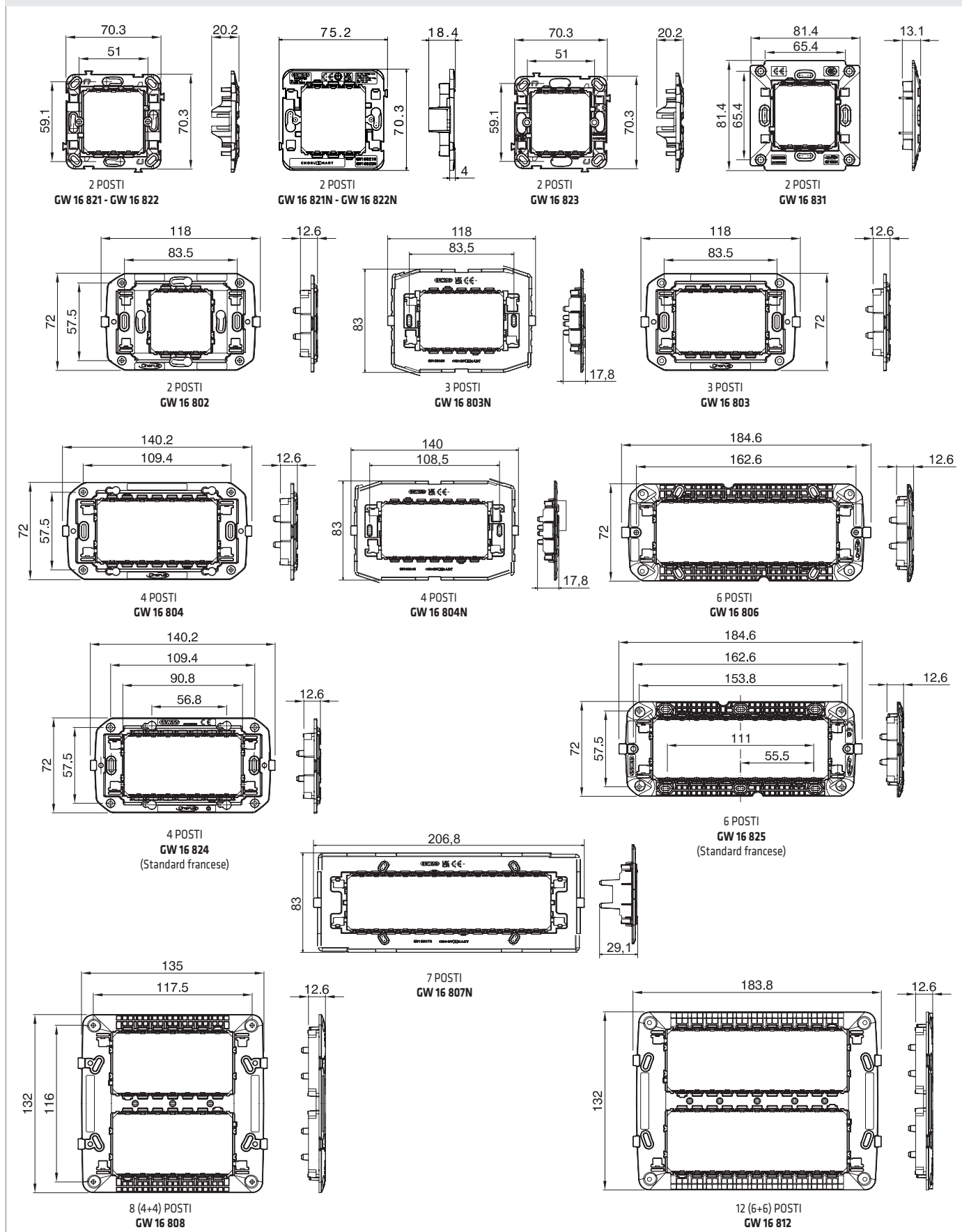

COMPOSIZIONE SUPPORTI PER PLACCHE INTERNAZIONALI

Composizione orizzontale (interasse 71mm)

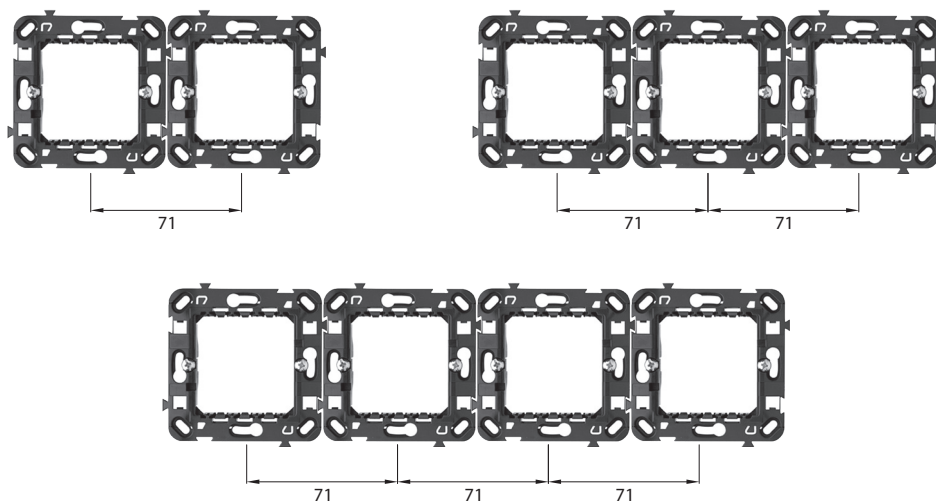

Composizione verticale (interasse 71mm)

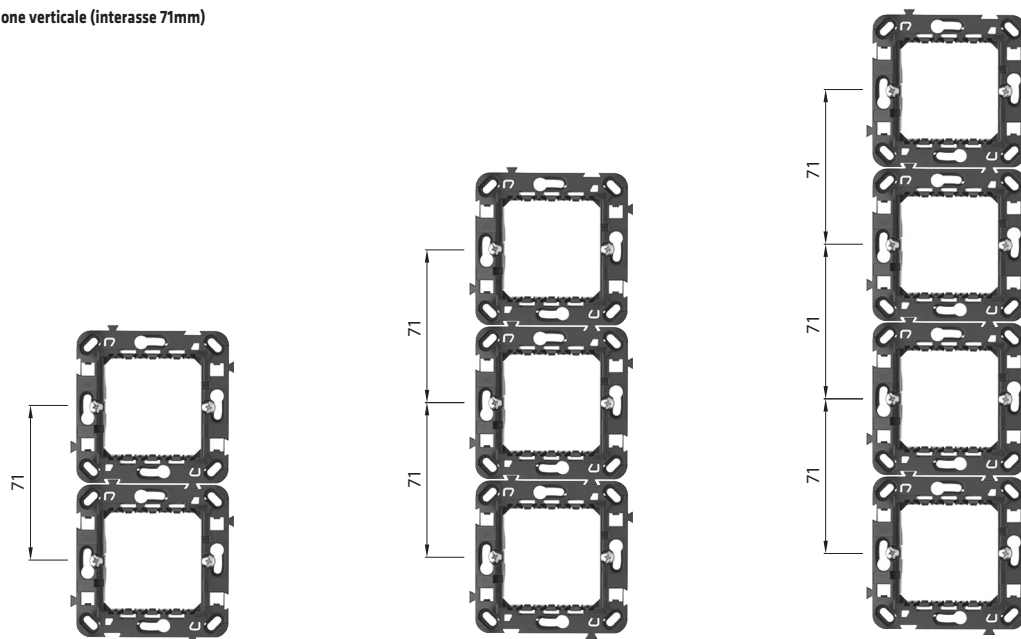

ChoruSmart - serie civile

INTERASSE SCATOLE PER IL CORRETTO FISSAGGIO DELLE PLACCHE CHORUSMART ONE, GEO, LUX, EGO e ICE (DISTANZE MINIME CONSIGLIATE)

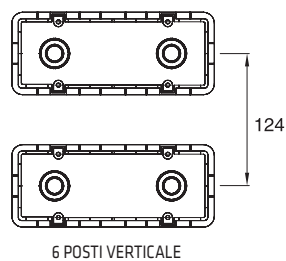
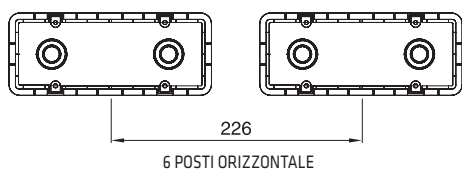
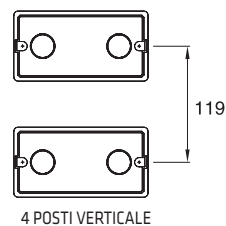
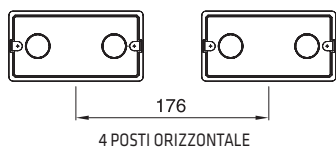
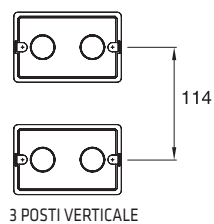
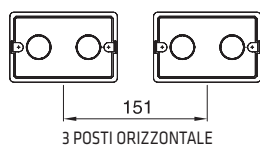

PLACCHE ONE

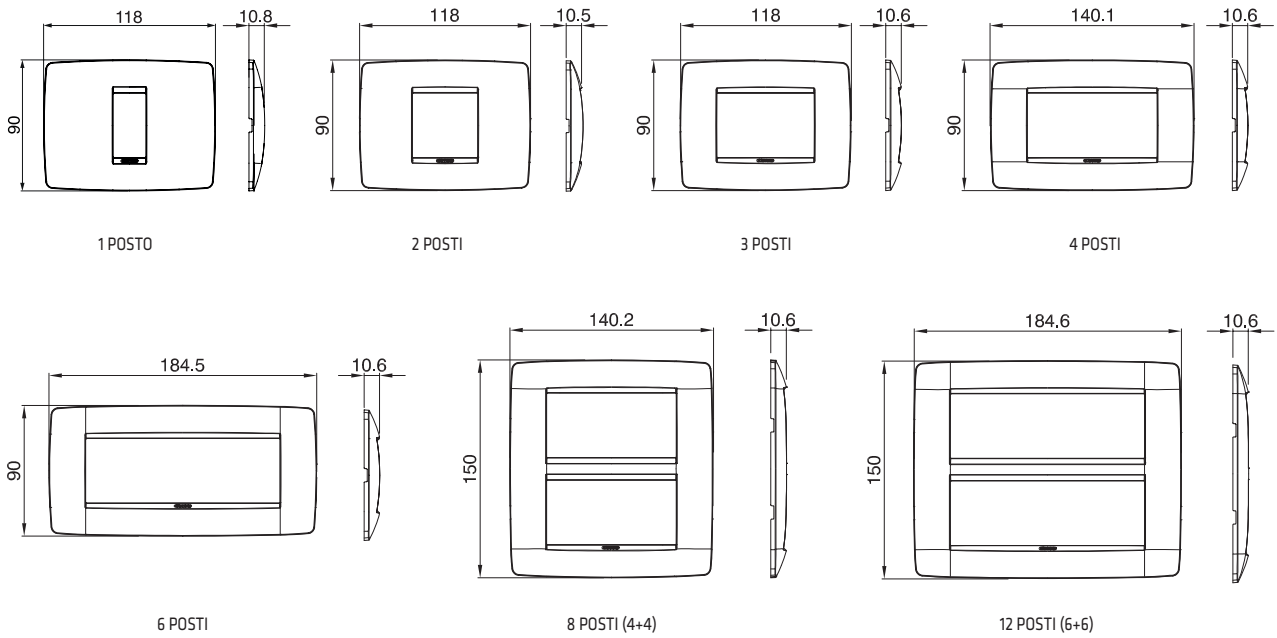

PLACCHE ONE INTERNAZIONALI

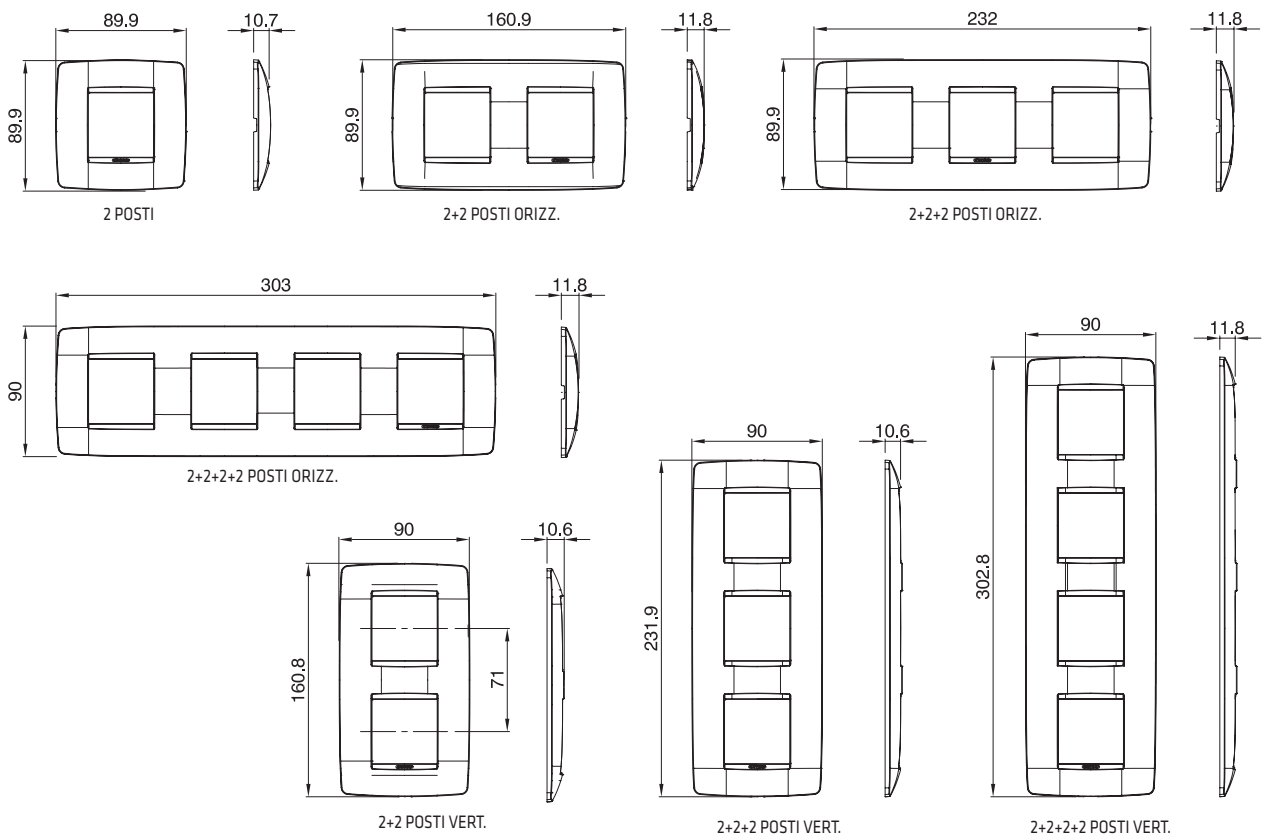

ChoruSmart - serie civile

PLACCHE EGO

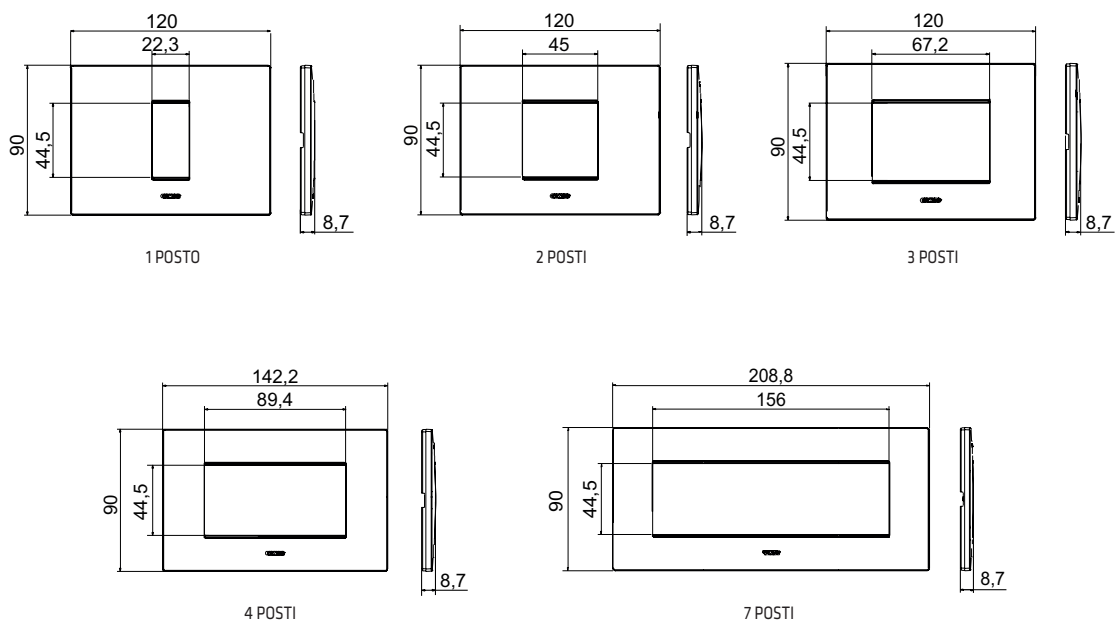

PLACCHE EGO SMART

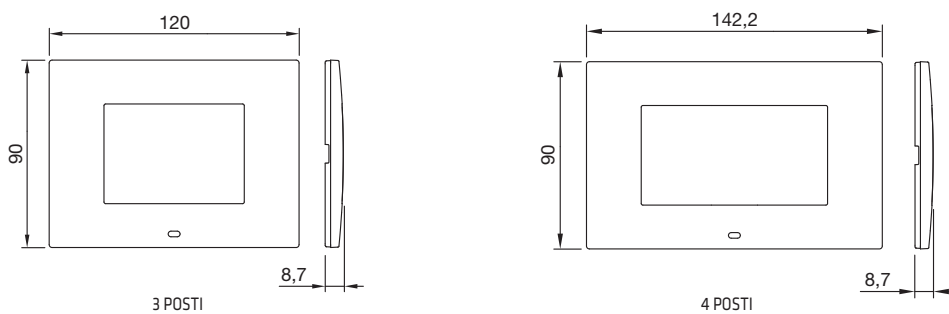

PLACCHE EGO INTERNAZIONALI

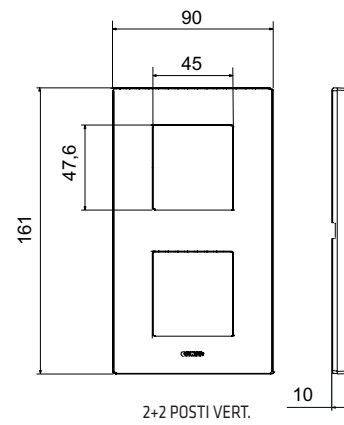
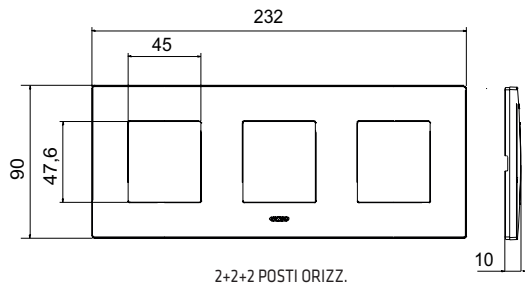
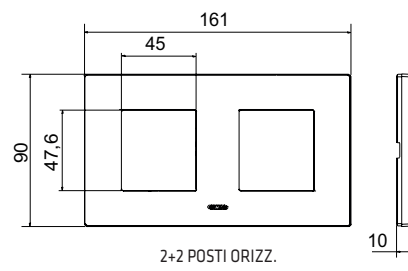
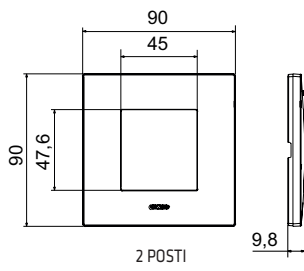

PLACCHE EGO SMART INTERNAZIONALI

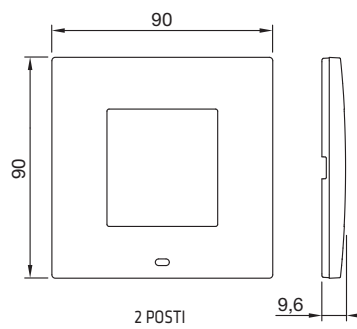

ChoruSmart - serie civile

PLACCHE GEO

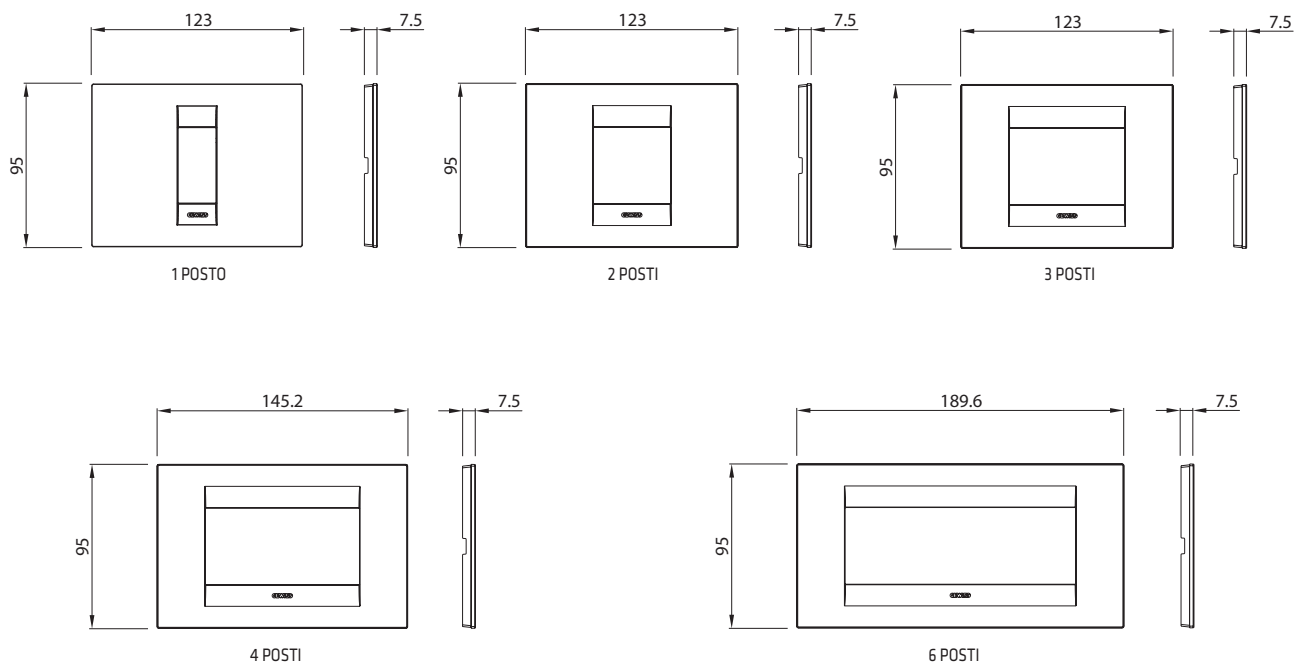

PLACCHE GEO INTERNAZIONALI

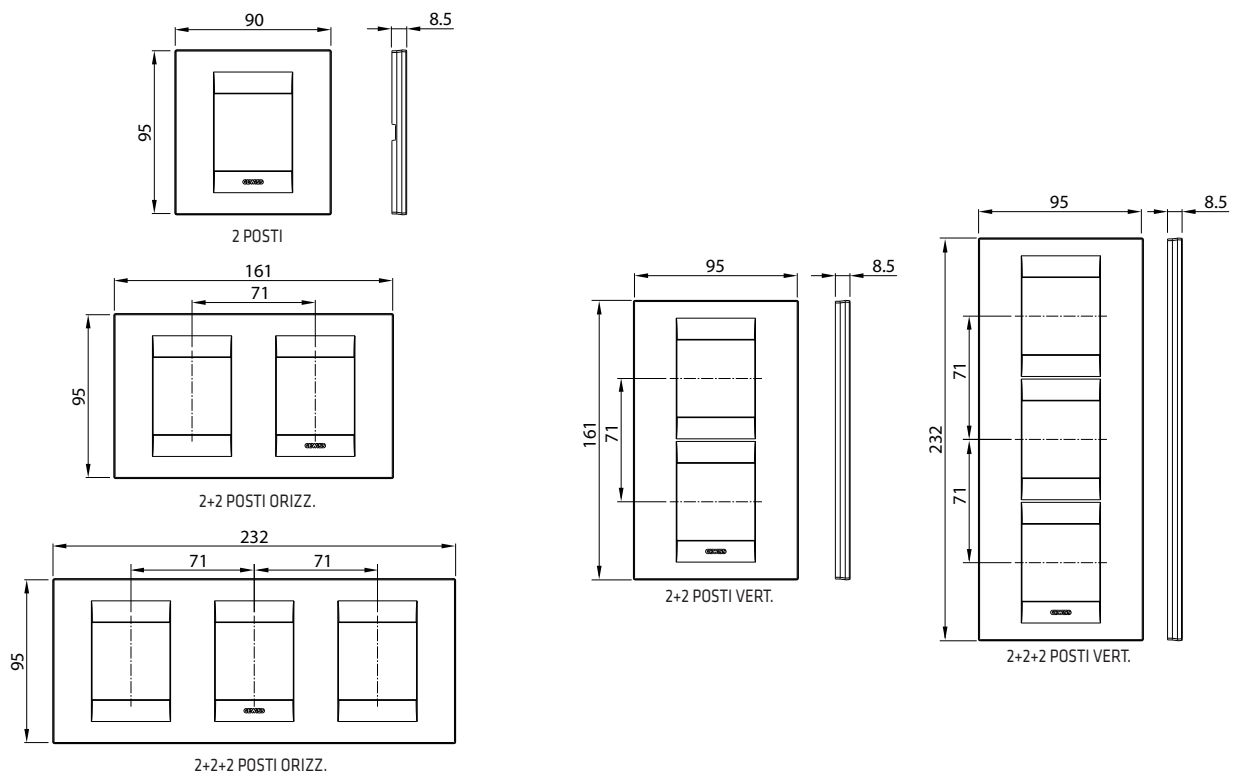

PLACCHE LUX

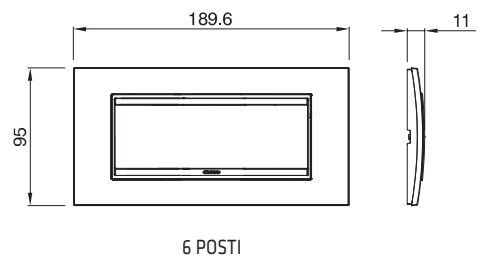
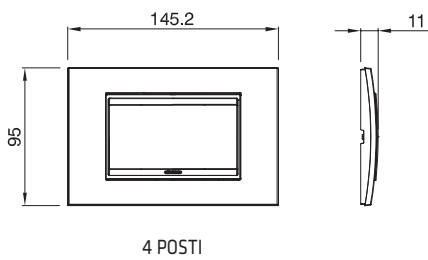
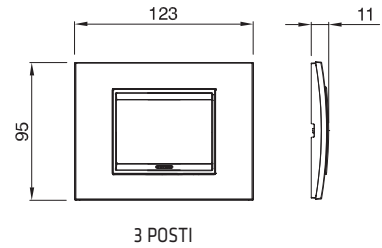
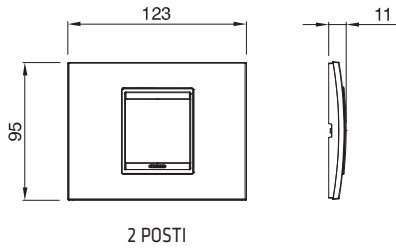

PLACCHE LUX INTERNAZIONALI

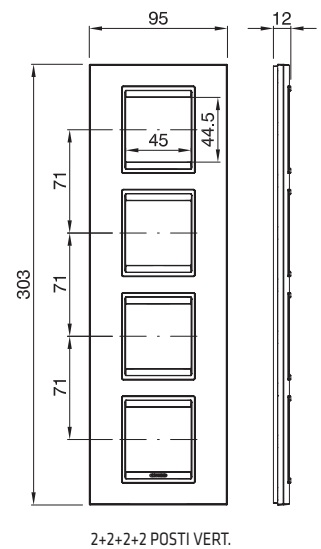
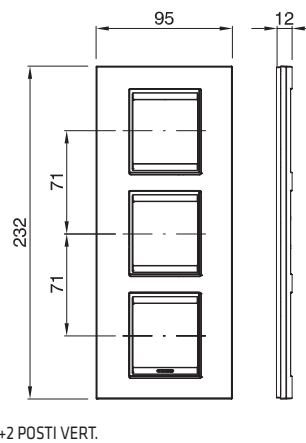
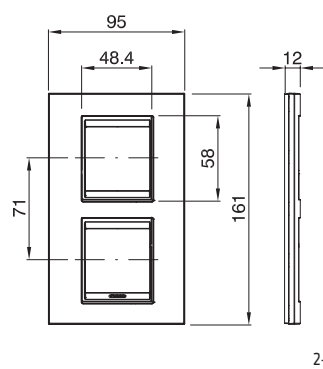
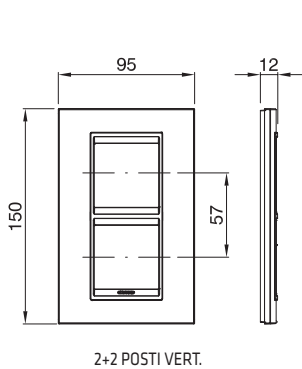
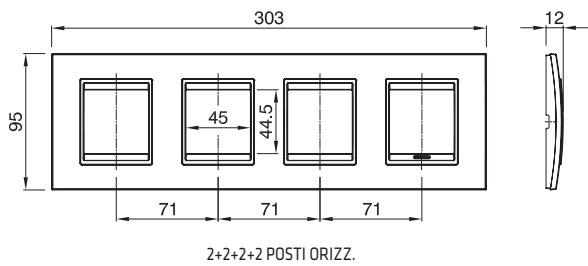
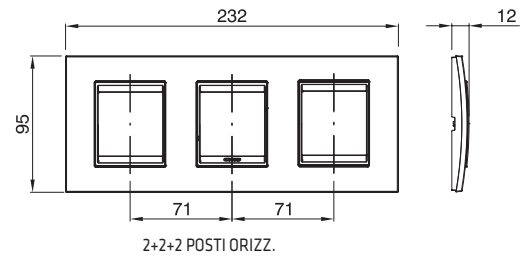
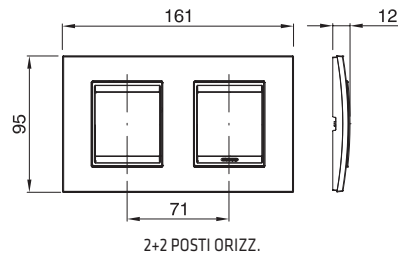
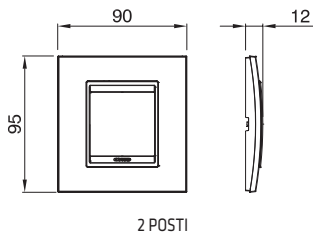

PLACCHE ICE

Placche ICE

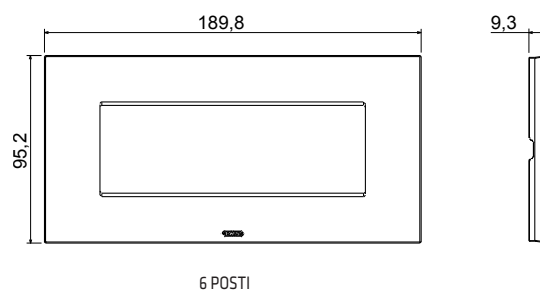
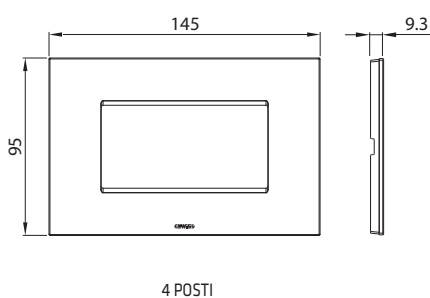
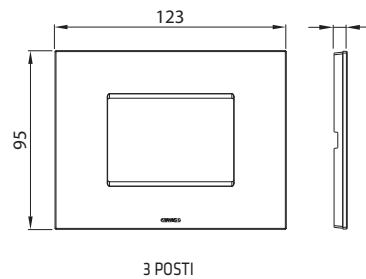
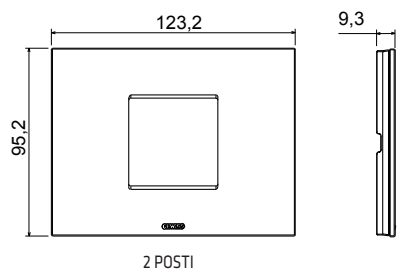

Placche ICE touch e placche ICE touch KNX con simboli intercambiabili

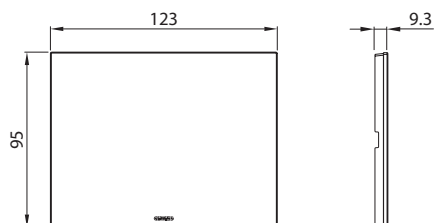

PLACCHE STAGNE - IP55

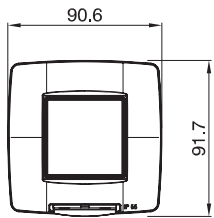

2 POSTI
GW 16 702 TB - GW 16 702 TN - GW 16 702 VT

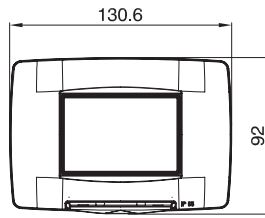

3 POSTI
GW 16 703 TB - GW 16 703 TN - GW 16 703 VT

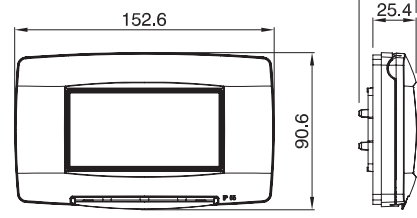

4 POSTI
GW 16 704 TB - GW 16 704 TN - GW 16 704 VT

PLANCE DA TAVOLO - ADATTE A PLACCHE ONE

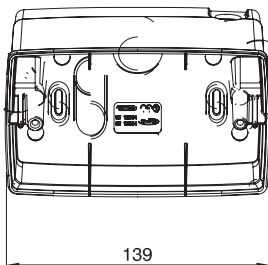

4 POSTI
GW 16 854 - GW 16 864

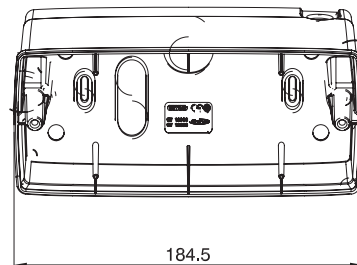
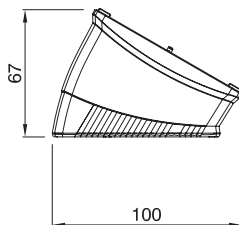

6 POSTI
GW 16 856 - GW 16 866

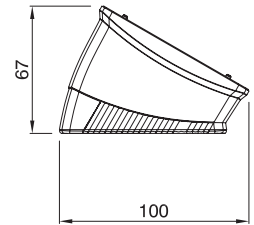

Coppia di serraggio viti: 0,8 Nm

ChoruSmart - serie civile

SCATOLE DA PARETE - ADATTE A PLACCHE ONE

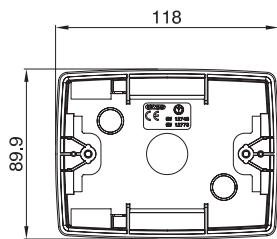

3 POSTI
GW 16 743 - GW 16 773

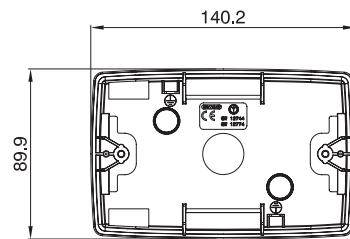
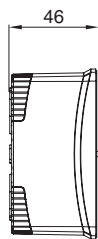

4 POSTI
GW 16 744 - GW 16 774



Coppia di serraggio viti: 0,8 Nm

SCATOLE DA PARETE - ADATTE A PLACCHE ONE INTERNATIONAL

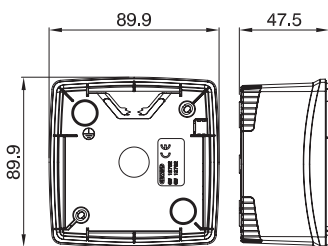

2 POSTI
GW 16 752 - GW 16 782

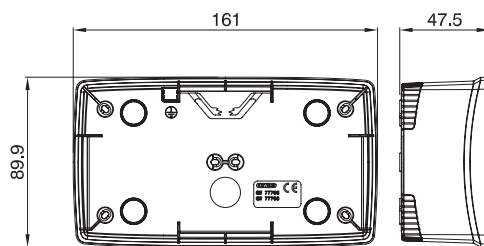

2+2 POSTI ORIZZ.
GW 16 753 - GW 16 783

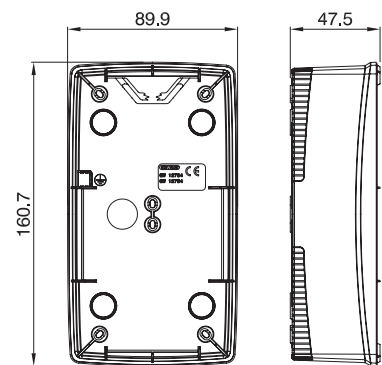

2+2 POSTI VERT.
GW 16 754 - GW 16 784

Coppia di serraggio viti: 0,8 Nm

PLACCHE AUTOPORTANTI PER PROFILATI E PANNELLI

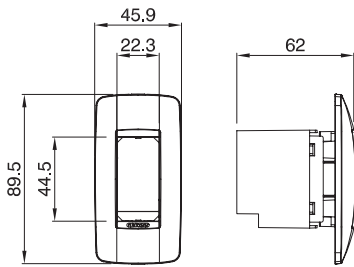

1 POSTO
GW 16 711 TB - GW 16 711 TN - GW 16 711 VT

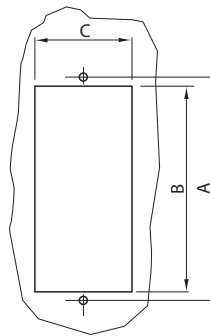

DIMENSIONI DELLO SCASSO

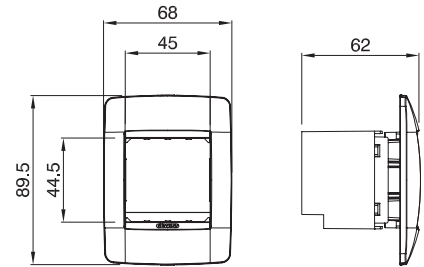

2 POSTI
GW 16 712 TB - GW 16 712 TN - GW 16 712 VT

Codice	A	B	C
GW 16 711 TB	67	54	31,5
GW 16 711 TN			
GW 16 711 VT			
GW 16 712 TB	67	54	56,5
GW 16 712 TN			
GW 16 712 VT			

PLACCHE CIECHE

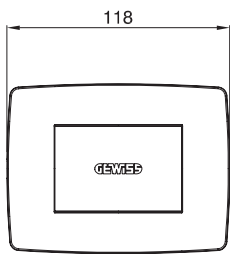

3 POSTI
GW 16 723 TB - GW 16 723 TN

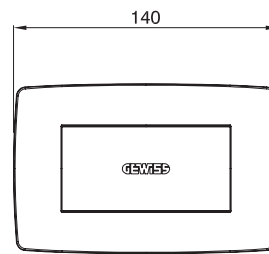
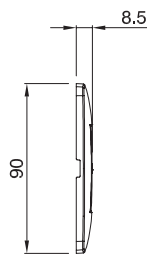

4 POSTI
GW 16 724 TB - GW 16 724 TN

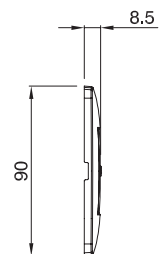

SUPPORTI GUIDA DIN

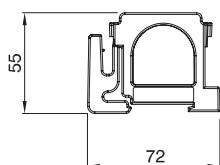

1 modulo
GW 16 841

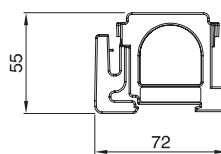

2 moduli
GW 16 842

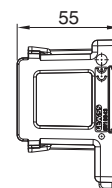
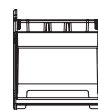

3 moduli
GW 16 843

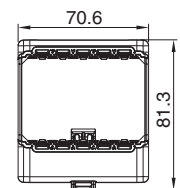

ChoruSmart - serie civile

CONTENITORI AUTOPORTANTI VUOTI PROTETTI IP40

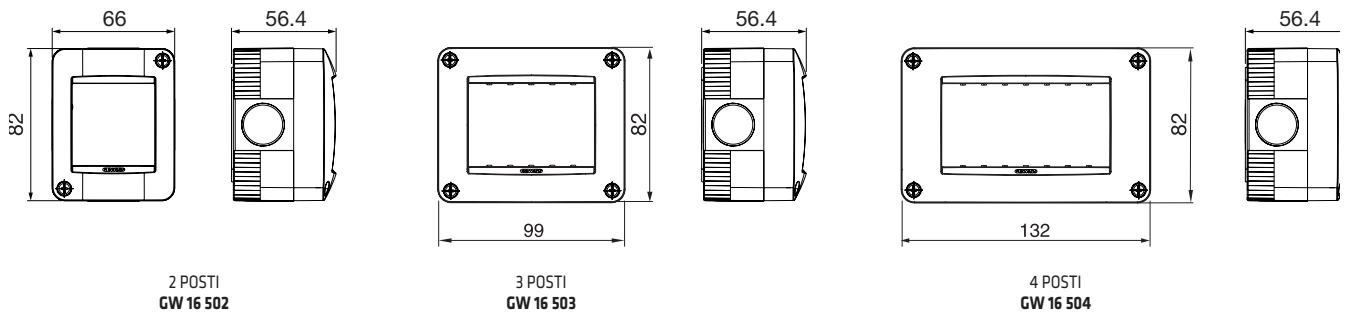

Coppia di serraggio viti: 0,8 Nm

CONTENITORI AUTOPORTANTI VUOTI STAGNI IP55

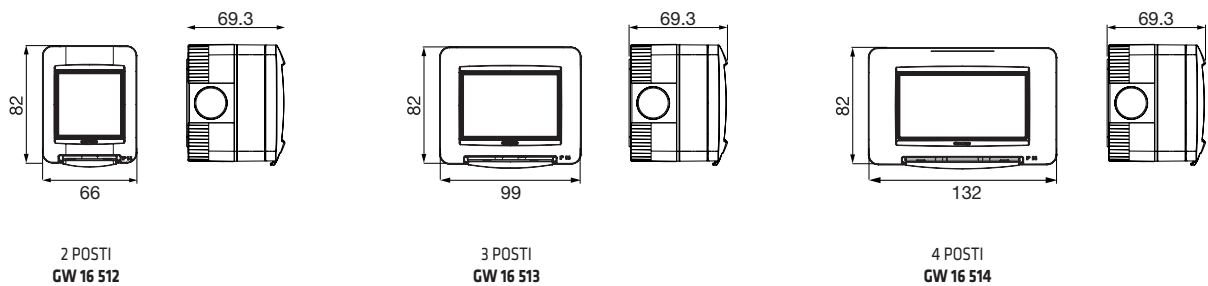

Coppia di serraggio viti: 0,8 Nm

ChoruSmart - serie civile

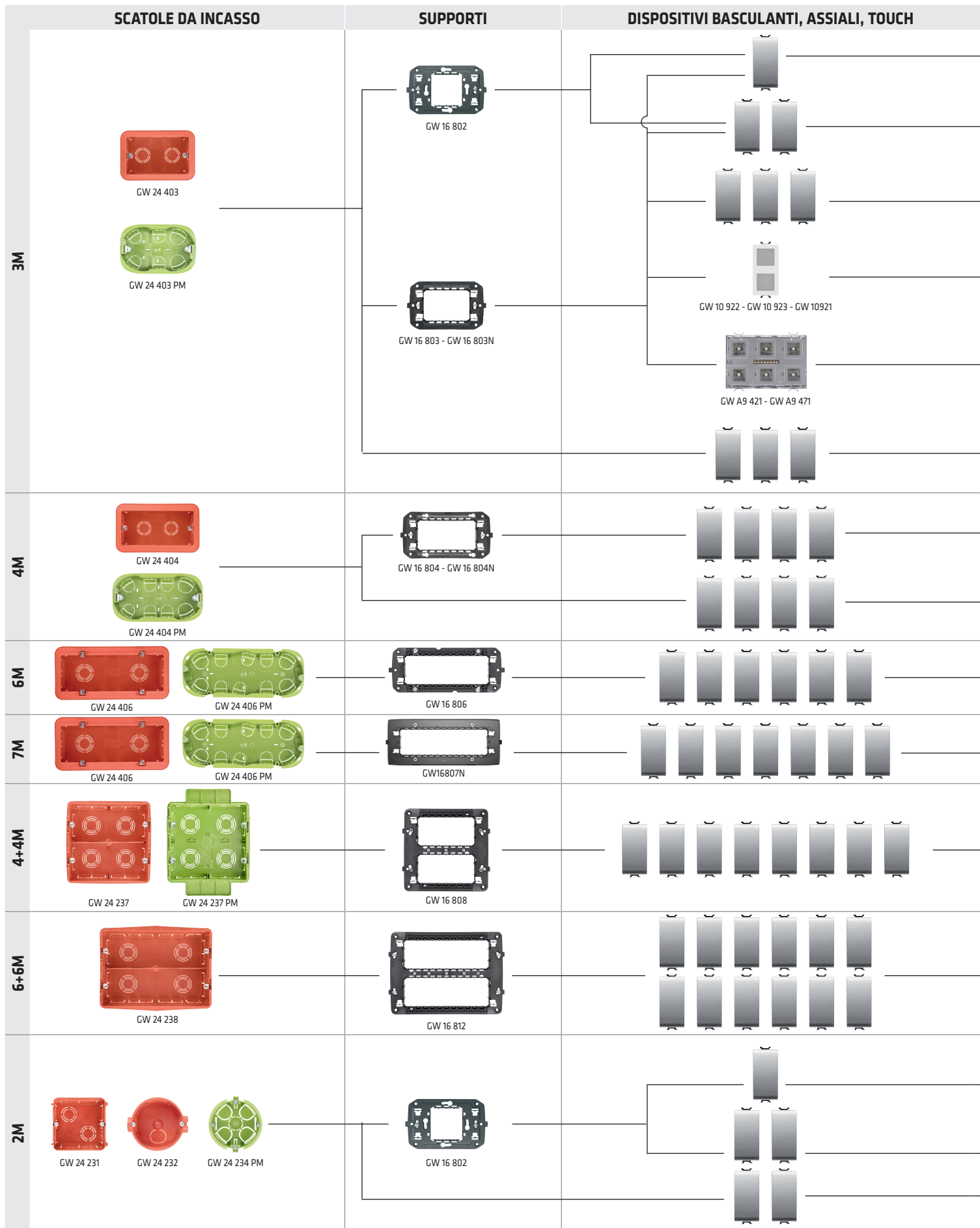

PLACCHE



ONE
GW 16 101 xx



GEO
GW 16 401 xx



EGO
GW 16 001 xx



ONE
GW 16 102 xx



GEO
GW 16 402 xx



EGO
GW 16 002 xx



LUX
GW 16 202 xx



ICE
GW 16 902 xx



ONE
GW 16 103 xx



GEO
GW 16 403 xx



EGO
GW 16 003 xx



EGO SMART
GW 16 003 Sxx (*)



LUX
GW 16 203 xx



ICE
GW 16 903 xx



ICE TOUCH
GW 16 955 xx

ICE TOUCH KNX (per pulsantieri con simboli intercambiabili)



GW 16 946 xx

Placche stagne IP55 (***)



GW 16 703 xx



ONE
GW 16 104 xx



GEO
GW 16 404 xx



EGO
GW 16 004 xx



EGO SMART
GW 16 004 Sxx (**)



LUX
GW 16 204 xx



ICE
GW 16 904 xx

Placche stagne IP55 (***)



GW 16 704 xx



ONE
GW 16 106 xx



GEO
GW 16 406 xx



LUX
GW 16 206 xx



ICE
GW 16 906 xx



EGO
GW 16 007 xx



ONE
GW 16 108 TB - GW 16 108 VT



ONE
GW 16 112 TB - GW 16 112 VT



ONE
GW 16 101 xx



GEO
GW 16 401 xx



EGO
GW 16 001 xx



ONE
GW 16 102 xx



GEO
GW 16 402 xx



EGO
GW 16 002 xx



LUX
GW 16 202 xx























Placche stagne IP55 (***)



GW 16 702 xx

(*) installabile solo su supporto GW16803N
(**) installabile solo su supporto GW16804N
(***) supporti già inclusi

ChoruSmart - serie civile

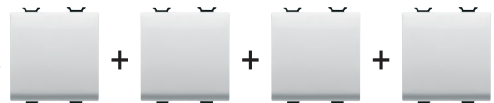
	SCATOLE DA INCASSO	SUPPORTI	DISPOSITIVI BASCULANTI, ASSIALI
2M	 GW 24 231  GW 24 234 PM  GW 24 232  GW 24 208  GW 24 209	 GW 16 822 - GW 16 822N (*)  GW 16 821 - GW 16 821N - GW 16 823 (**) 	
2+2M ORIZZONTALI	 2 x GW 24 231  2 x GW 24 234 PM  2 x GW 24 232	 2 x GW 16 822 - GW 16 822N	
2+2+2M ORIZZONTALI	 3 x GW 24 231  3 x GW 24 234 PM  3 x GW 24 232	 3 x GW 16 822 - GW 16 822N	
2+2+2+2M ORIZZONTALI	 4 x GW 24 231  4 x GW 24 234 PM  4 x GW 24 232	 4 x GW 16 822 - GW 16 822N	

(*) GW16822N: installabile su scatole GW24231 e GW24232 solo con viti allineate orizzontalmente.

(**) GW16821 - GW16821N - GW16823: installabili su scatola GW24232 solo con viti allineate verticalmente

PLACCHE

**ONE
INTERNAZIONALI**



GW 16 122 xx

**GEO
INTERNAZIONALI**



GW 16 422 xx

**EGO
INTERNAZIONALI**



GW 16 022 xx

**EGO SMART
INTERNAZIONALI**



GW 16 022 Sxx (*)

**LUX
INTERNAZIONALI**



GW 16 222 xx

**ONE
INTERNAZIONALI**

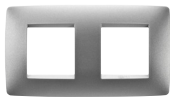

GW 16 123 xx

**GEO
INTERNAZIONALI**



GW 16 423 xx

**EGO
INTERNAZIONALI**



GW 16 023 xx

**LUX
INTERNAZIONALI**



GW 16 223 xx

**ONE
INTERNAZIONALI**



GW 16 126 xx

**GEO
INTERNAZIONALI**



GW 16 426 xx

**EGO
INTERNAZIONALI**



GW 16 026 xx

**LUX
INTERNAZIONALI**



GW 16 226 xx

**ONE
INTERNAZIONALI**



GW 16 128 xx

**LUX
INTERNAZIONALI**



GW 16 228 xx

(*) installabile solo su supporti GW16821N e GW16822N

ChoruSmart - serie civile

	SCATOLE DA INCASSO	SUPPORTI	DISPOSITIVI BASCULANTI, ASSIALI
2+2M VERTICALI	<p>2 x GW 24 231</p> <p>2 x GW 24 234 PM</p> <p>2 x GW 24 232</p>	<p>2 x GW 16 822</p> <p>2 x GW 16 821 - GW 16 822 - GW 16 823</p>	
2+2+2M VERTICALI	<p>3 x GW 24 231</p> <p>3 x GW 24 234 PM</p> <p>3 x GW 24 232</p>	<p>3 x GW 16 822</p> <p>3 x GW 16 821 - GW 16 822 - GW 16 823</p>	
2+2+2+2M VERTICALI	<p>4 x GW 24 231</p> <p>4 x GW 24 234 PM</p> <p>4 x GW 24 232</p>	<p>4 x GW 16 822</p> <p>4 x GW 16 821 - GW 16 822 - GW 16 823</p>	

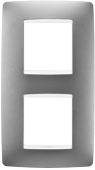
PLACCHE**ONE
INTERNAZIONALI**

GW 16 124 xx

**GEO
INTERNAZIONALI**

GW 16 424 xx

**EGO
INTERNAZIONALI**

GW 16 024 xx

**LUX
INTERNAZIONALI**

GW 16 224 xx

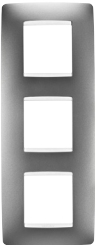
**ONE
INTERNAZIONALI**

GW 16 127 xx

**GEO
INTERNAZIONALI**

GW 16 427 xx

**LUX
INTERNAZIONALI**

GW 16 227 xx











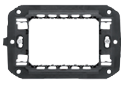





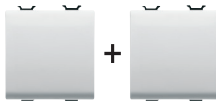

**ONE
INTERNAZIONALI**

GW 16 129 xx

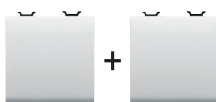
**LUX
INTERNAZIONALI**

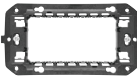
GW 16 229 xx

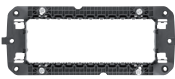
ChoruSmart - serie civile

	SCATOLE DA PARETE E PLANCE DA TAVOLO	SUPPORTI	DISPOSITIVI BASCULANTI, ASSIALI
3M	 <p>GW 16 743 - GW 16 773</p>	 <p>GW 16 803</p>	
4M	 <p>GW 16 744 - GW 16 774</p>	 <p>GW 16 804</p>	
2M	 <p>GW 16 752 - GW 16 782</p>	 <p>GW 16 822</p>	
2+2M ORIZZONTALI	 <p>GW 16 753 - GW 16 783</p>	 <p>2 x GW 16 822</p>	
2+2M VERTICALI	 <p>GW 16 754 - GW 16 784</p>	 <p>2 x GW 16 822</p>	
4M	 <p>GW 16 854 - GW 16 864</p>	 <p>GW 16 804</p>	
6M	 <p>GW 16 856 - GW 16 866</p>	 <p>GW 16 806</p>	

PLACCHE**ONE**

GW 16 103 xx

ONE

GW 16 104 xx

**ONE
INTERNAZIONALI**

GW 16 122 xx

**ONE
INTERNAZIONALI**

GW 16 123 xx

**ONE
INTERNAZIONALI**

GW 16 124 xx

ONE

GW 16 104 xx

ONE

GW 16 106 xx