

BCF 3.81/15/180LRZE SN OR BX

Weidmüller Interface GmbH & Co. KG
 Klingenbergstraße 26
 D-32758 Detmold
 Germany

www.weidmueller.com

Product image

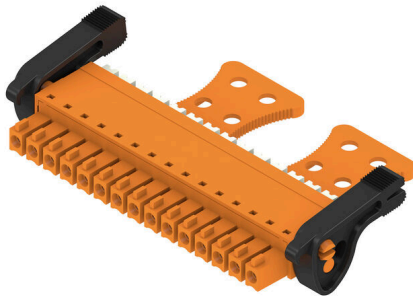

PUSH IN - Weidmüller's innovative connection system simplifies the wire connection process.

The benefits for users and applications:

- High packaging density due to very low component height. Simply insert the prepared wire - finished
- High component density with the compact SCDN / SCDN-THR two-tier pin header
- Simplified processing due to integrated push buttons for opening the clamping unit
- Intuitive handling – since the wire-entry area and handling area are clearly separated
- tool-free locking and releasing when using Weidmüller's patented release latch (LR)

The Weidmüller plug-in connectors, pitch 3.81 mm (0.15 inch), are compatible with the layout of customary plug-in connectors, can be coded and provide space for printing.

General ordering data

Version	PCB plug-in connector, female plug, 3.81 mm, Number of poles: 15, 180°, PUSH IN with push button, Clamping range, max. : 1.5 mm², Box
Order No.	2442980000
Type	BCF 3.81/15/180LRZE SN OR BX
GTIN (EAN)	4050118542929
Qty.	50 items
Product data	IEC: 320 V / 17.5 A / 0.14 - 1.5 mm² UL: 300 V / 10 A / AWG 26 - AWG 16
Packaging	Box

BCF 3.81/15/180LRZE SN OR BX

Weidmüller Interface GmbH & Co. KG
Klingenbergstraße 26
D-32758 Detmold
Germany

www.weidmueller.com

Technical data

Approvals

Approvals



ROHS Conform

UL File Number Search [UL Website](#)

Certificate No. (cURus) E60693

Dimensions and weights

Depth	34.6 mm	Depth (inches)	1.3622 inch
Height	15.09 mm	Height (inches)	0.5941 inch
Width	67.74 mm	Width (inches)	2.6669 inch
Net weight	12.74 g		

Environmental Product Compliance

RoHS Compliance Status	Compliant without exemption
REACH SVHC	No SVHC above 0.1 wt%

System Parameters

Product family	OMNIMATE Signal - series BC/SC 3.81	Type of connection	Field connection
Wire connection method	PUSH IN with push button	Pitch in mm (P)	3.81 mm
Pitch in inches (P)	0.150 "	Conductor outlet direction	180°
Number of poles	15	L1 in mm	53.34 mm
L1 in inches	2.100 "	Number of rows	1
Pin series quantity	1	Rated cross-section	1 mm ²
Touch-safe protection acc. to DIN VDE 57 106	Safe from finger touch	Touch-safe protection acc. to DIN VDE 0470	IP20 plugged/ IP10 unplugged
Protection degree	IP20	Volume resistance	≤5 mΩ
Can be coded	Yes	Stripping length	9 mm
Screwdriver blade	0.4 x 2.5	Screwdriver blade standard	DIN 5264
Plugging cycles	25	Plugging force/pole, max.	8 N
Pulling force/pole, max.	7 N		

Material data

Insulating material	PA 66 GF 30	Colour	orange
Colour of operational elements	white	Colour chart (similar)	RAL 2000
Insulating material group	II	Comparative Tracking Index (CTI)	≥ 550
Insulation resistance	≥ 108 Ω	Moisture Level (MSL)	
UL 94 flammability rating	V-0	Contact material	Copper alloy
Contact surface	tinned	Layer structure of plug contact	4...8 μm Sn matt
Storage temperature, min.	-40 °C	Storage temperature, max.	70 °C
Operating temperature, min.	-50 °C	Operating temperature, max.	120 °C
Temperature range, installation, min.	-25 °C	Temperature range, installation, max.	120 °C

Conductors suitable for connection

Clamping range, min.	0.14 mm ²
Clamping range, max.	1.5 mm ²
Wire connection cross section AWG, min.	AWG 26
Wire connection cross section AWG, max.	AWG 16

Creation date 25.02.2026 05:34:13 MEZ

Catalogue status / Drawings

BCF 3.81/15/180LRZE SN OR BX

Weidmüller Interface GmbH & Co. KG
 Klingenbergstraße 26
 D-32758 Detmold
 Germany

www.weidmueller.com

Technical data

Solid, min. H05(07) V-U	0.14 mm ²
Solid, max. H05(07) V-U	1.5 mm ²
Flexible, min. H05(07) V-K	0.14 mm ²
Flexible, max. H05(07) V-K	1.5 mm ²
w. plastic collar ferrule, DIN 46228 pt 4, 0.25 mm ² min.	
w. plastic collar ferrule, DIN 46228 pt 4, 1 mm ² max.	
w. wire end ferrule, DIN 46228 pt 1, min.	0.25 mm ²
w. wire end ferrule, DIN 46228 pt 1, max.	1.5 mm ²
Plug gauge in accordance with EN 60999 a x b; ø	2.4 mm x 1.5 mm; 1.9mm

Clampable conductor	Cross-section for conductor connection	Type	fine-wired
		nominal	0.5 mm ²
wire end ferrule	wire end ferrule	Stripping length	nominal 12 mm
		Recommended wire-end ferrule	H0,5/16 OR
		Stripping length	nominal 10 mm
		Recommended wire-end ferrule	H0,5/10
Cross-section for conductor connection	Type	fine-wired	
	nominal	0.75 mm ²	
wire end ferrule	wire end ferrule	Stripping length	nominal 12 mm
		Recommended wire-end ferrule	H0,75/16 W
		Stripping length	nominal 10 mm
		Recommended wire-end ferrule	H0,75/10
Cross-section for conductor connection	Type	fine-wired	
	nominal	1 mm ²	
wire end ferrule	wire end ferrule	Stripping length	nominal 12 mm
		Recommended wire-end ferrule	H1,0/16D R
		Stripping length	nominal 10 mm
		Recommended wire-end ferrule	H1,0/10
Cross-section for conductor connection	Type	fine-wired	
	nominal	0.34 mm ²	
wire end ferrule	wire end ferrule	Stripping length	nominal 10 mm
		Recommended wire-end ferrule	H0,34/12 TK

Reference text The outside diameter of the plastic collar should not be larger than the pitch (P). Length of ferrules is to be chosen depending on the product and the rated voltage.

Rated data acc. to IEC

tested acc. to standard	IEC 60664-1, IEC 61984	Rated current, min. number of poles (Tu=20°C)	17.5 A
Rated current, max. number of poles (Tu=20°C)	17.5 A	Rated current, min. number of poles (Tu=40°C)	17.5 A
Rated current, max. number of poles (Tu=40°C)	16.3 A	Rated voltage for surge voltage class / pollution degree II/2	320 V
Rated voltage for surge voltage class / pollution degree III/2	160 V	Rated voltage for surge voltage class / pollution degree III/3	160 V
Rated impulse voltage for surge voltage class/ pollution degree II/2	2.5 kV	Rated impulse voltage for surge voltage class/ pollution degree III/2	2.5 kV
Rated impulse voltage for surge voltage class/ contamination degree III/3	2.5 kV	Short-time withstand current resistance	3 x 1s with 76 A

BCF 3.81/15/180LRZE SN OR BX

Weidmüller Interface GmbH & Co. KG

Klingenbergstraße 26

D-32758 Detmold

Germany

www.weidmueller.com

Technical data

Rated data acc. to CSA

Rated voltage (Use group B / CSA)	300 V	Rated voltage (Use group C / CSA)	50 V
Rated voltage (Use group D / CSA)	300 V	Rated current (Use group B / CSA)	10 A
Rated current (Use group D / CSA)	10 A	Wire cross-section, AWG, min.	AWG 26
Wire cross-section, AWG, max.	AWG 16		

Rated data acc. to UL 1059

Institute (cURus)	CURUS	Certificate No. (cURus)	E60693
Rated voltage (Use group B / UL 1059)	300 V	Rated voltage (Use group D / UL 1059)	300 V
Rated current (Use group B / UL 1059)	10 A	Rated current (Use group D / UL 1059)	10 A
Wire cross-section, AWG, min.	AWG 26	Wire cross-section, AWG, max.	AWG 16
Reference to approval values	Specifications are maximum values, details - see approval certificate.		

Packing

Packaging	Box	VPE length	165.00 mm
VPE width	118.00 mm	VPE height	46.00 mm

Type tests

Test: Misengagement (Non-interchangeability)	Test	visual examination
	Evaluation	passed

Important note

IPC conformity
Conformity: The products are developed, manufactured and delivered according international recognized standards and norms and comply with the assured properties in the data sheet resp. fulfill decorative properties in accordance with IPC-A-610 "Class 2". Further claims on the products can be evaluated on request.

Notes

- Rated data refer only to the component itself. Clearance and creepage distances to other components are to be designed in accordance with the relevant application standards.
- Rated current related to rated cross-section & min. No. of poles.
- P on drawing = pitch
- Conductors suitable for connection: 1.5 mm² with wire-end ferrule with plastic collar, DIN 46 228/1, with a rated voltage of 125V/2.5 kV with III/3 or 250 V/2.5 kV with II/2
- Crimp shape A for wire-end ferrules with crimping tools PZ 1,5 (order no. 9005990000) or PZ 6/5 (order no. 9011460000) for larger wire cross-sections recommended.
- Wire end ferrule without plastic collar to DIN 46228/1
- Wire end ferrule with plastic collar to DIN 46228/4
- The test point can only be used as potential-pickup point.
- In accordance with IEC 61984, OMNIMATE-connectors are connectors without breaking capacity (COC). During designated use, connectors are not allowed to be engaged or disengaged when live or under load
- Long term storage of the product with average temperature of 50 °C and maximum humidity 70%, 36 months

Classifications

ETIM 8.0	EC002638	ETIM 9.0	EC002638
ETIM 10.0	EC002638	ECLASS 14.0	27-46-02-02
ECLASS 15.0	27-46-02-02		

BCF 3.81/15/180LRZE SN OR BX

Weidmüller Interface GmbH & Co. KG
 Klingenbergstraße 26
 D-32758 Detmold
 Germany

Drawings

www.weidmueller.com

Product image

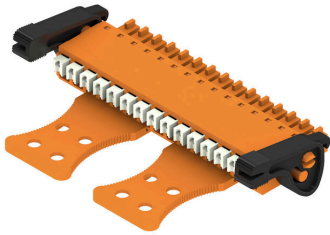

Dimensional drawing

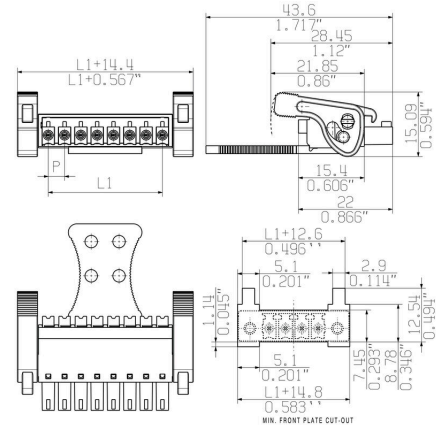

Graph

BCF 3.81/./180 - SC 3.81/./90



Graph

BCF 3.81/./180 - SCDN 3.81/./90



Graph

BCF 3.81/./180 - SC 3.81/./180



Example of use



BCF 3.81/15/180LRZE SN OR BX

Weidmüller Interface GmbH & Co. KG
Klingenbergstraße 26
D-32758 Detmold
Germany

www.weidmueller.com

Drawings

Example of use



Product benefits



Self-locking Immediately on plugging in

Product benefits

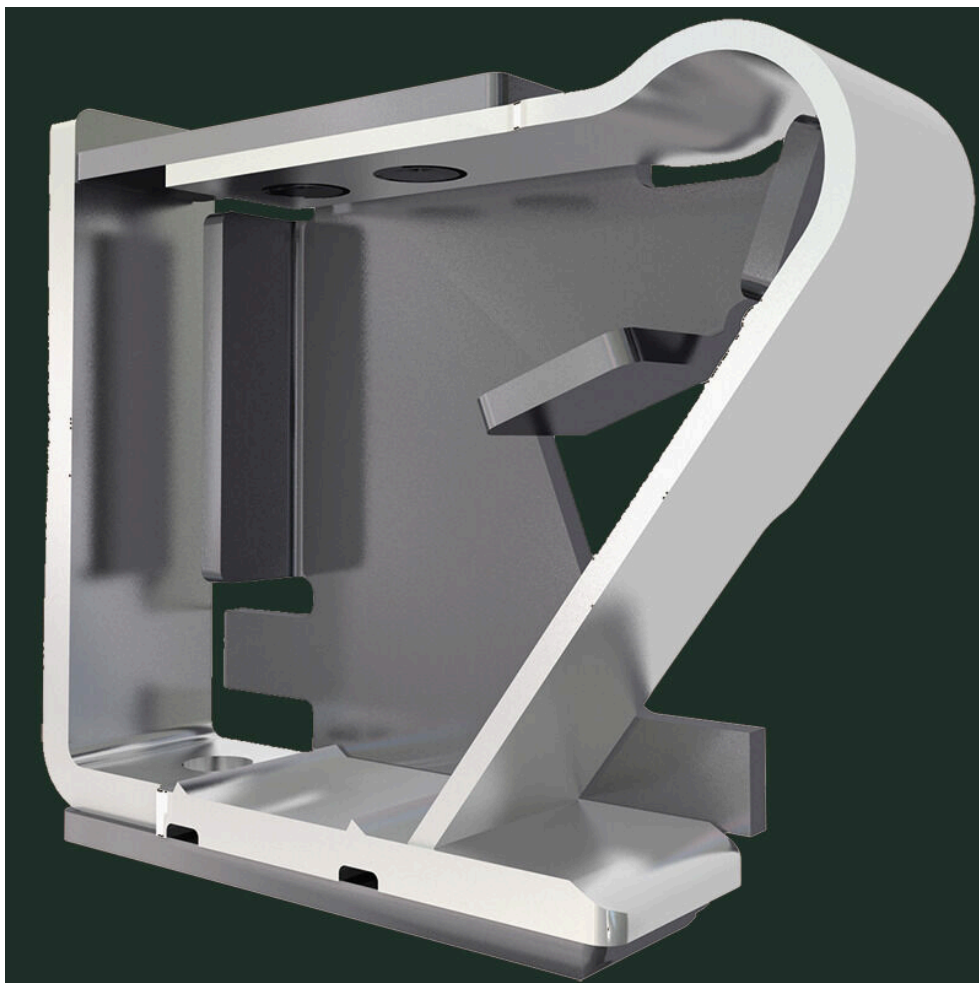

Solid PUSH IN contactSafe and durable