

**DRM270110LT**

**Weidmüller Interface GmbH & Co. KG**  
 Klingenbergstraße 26  
 D-32758 Detmold  
 Germany

www.weidmueller.com

**Product image**



Similar to illustration

Individual relays within the D-SERIES DRM

- 2 CO contacts
- AC coils
- With integrated status LED and test button

**General ordering data**

Version	D-SERIES DRM, Relay, Number of contacts: 2, CO contact, AgNi flash gold-plated, Rated control voltage: 110 V DC, Continuous current: 10 A, Plug-in connection
Order No.	<a href="#">7760056071</a>
Type	DRM270110LT
GTIN (EAN)	403224885584 1
Qty.	20 items

## DRM270110LT

Weidmüller Interface GmbH &amp; Co. KG

Klingenbergstraße 26

D-32758 Detmold

Germany

www.weidmueller.com

## Technical data

## Approvals

Approvals



ROHS Conform

UL File Number Search [UL Website](#)

Certificate No. (cURus) E312083

## Dimensions and weights

Depth	35.7 mm	Depth (inches)	1.4055 inch
Height	27.4 mm	Height (inches)	1.0787 inch
Width	21 mm	Width (inches)	0.8268 inch
Net weight	34.15 g		

## Temperatures

Storage temperature	-40 °C...70 °C	Ambient temperature	-40 °C...60 °C
Operating temperature		Humidity	35...85 % rel. humidity, no condensation

## Environmental Product Compliance

RoHS Compliance Status	Compliant without exemption
REACH SVHC	No SVHC above 0.1 wt%

## Rated data UL

Certificate No. (cURus) E312083

## Control side

Rated control voltage	110 V DC	Rated current DC	10 mA
Power rating	1.2 W	Coil resistance	11000 Ω ± 10 %
Status indicator	Green LED		

## Load side

Rated switching voltage	250 V AC	Continuous current	10 A
Max. switching frequency at rated load	0.1 Hz	Max. switching voltage, AC	250 V
Inrush current	20 A / 50 ms	AC switching capacity (resistive), max.	2500 VA
DC switching capacity (resistive), max.	240 W @ 24 V	Switch-on delay	<20 ms
Switch-off delay	<20 ms	Contact type	2 CO contact (AgNi flash gold-plated)
Mechanical service life	20 x 10 <sup>6</sup> switching cycles	Min. switching power	10 mA @ 12 V, 100 mA @ 5 V

## General data

Test button available	Yes		
Version of test button	Lockable test button, Momentary test button		
Mechanical switch position indicator	Yes		
Colour	Transparent		
UL94 flammability rating component	Component	Relay cover	
	UL94 flammability rating	V-2	

### Technical data

Component	Relay baseplate
UL94 flammability rating	V-0
Component	Relay status indicator
UL94 flammability rating	HB
Component	Relay test button
UL94 flammability rating	HB

### Insulation coordination

Rated voltage	250 V	Pollution severity	2
Surge voltage category	III	Clearance and creepage distances for control side - load side	≥ 5.5 mm
Dielectric strength for control side - load side	1.8 kVeff / 1 min.	Dielectric strength of neighbouring contacts	1 kVeff / 1 min
Dielectric strength of open contact	1 kVeff / 1 min	Impulse withstand voltage	6 kV (1.2/50 µs)
Protection degree	IP20		

### Further details of approvals / standards

Certificate No. (cURus)	E312083
-------------------------	---------

### Connection data

Wire connection method	Plug-in connection
------------------------	--------------------

### Classifications

ETIM 8.0	EC001437	ETIM 9.0	EC001437
ETIM 10.0	EC001437	ECLASS 14.0	27-37-16-01
ECLASS 15.0	27-37-16-01		

Drawings

Wiring diagram

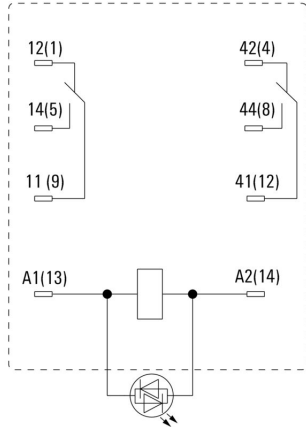

View of Pins from below

Graph

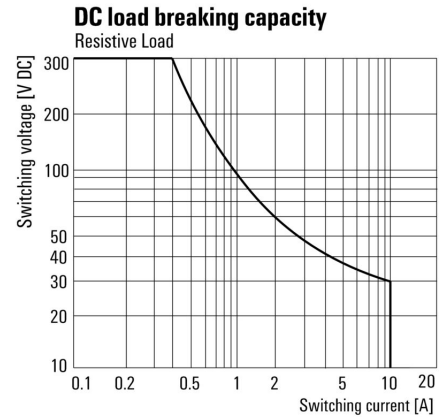

DC load limit curve Resistive load

Graph

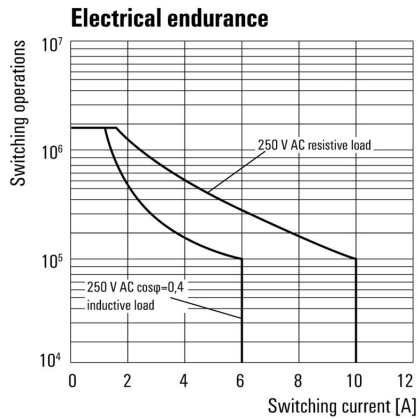

Electrical service life

Graph

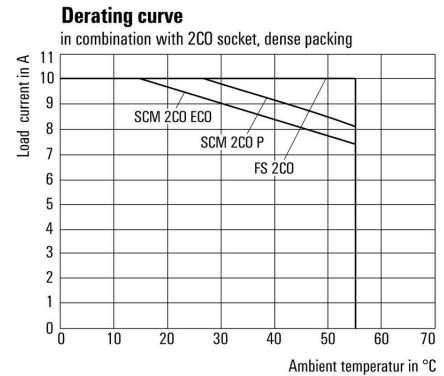

Derating curve Relay in combination with base

Graph

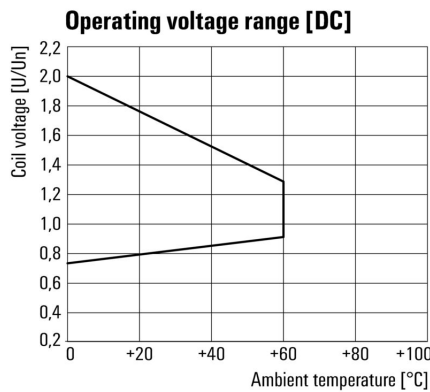

DC operational voltage range

Dimensional drawing

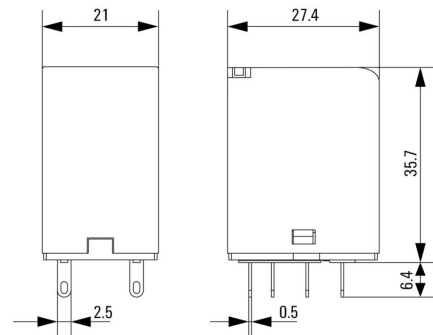

**DRM270110LT**

**Weidmüller Interface GmbH & Co. KG**  
 Klingenbergstraße 26  
 D-32758 Detmold  
 Germany

**Drawings**

www.weidmueller.com

**Miscellaneous**

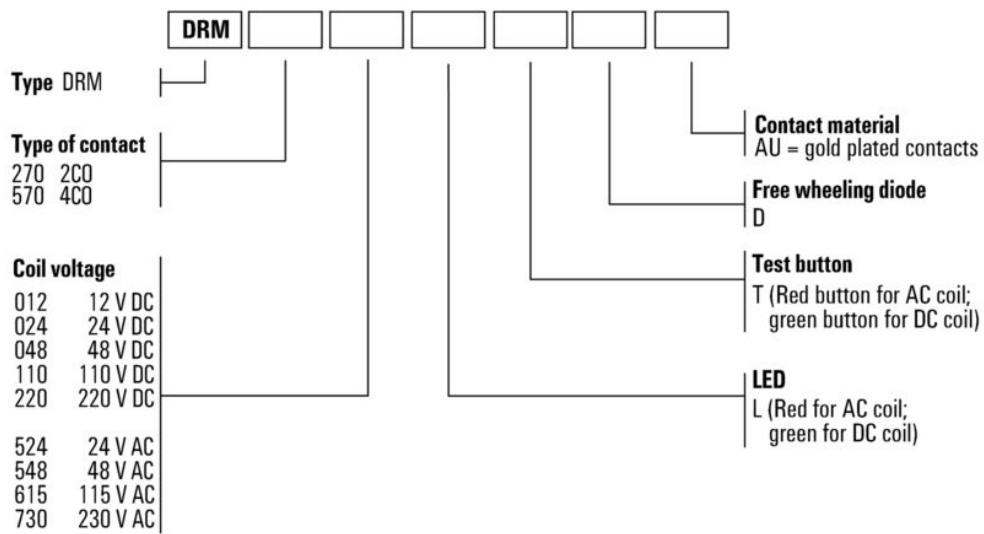

Type codes

## Accessories

### Sockets



Relay sockets for the D-SERIES DRM relays

- 2 and 4 CO contacts
- Screw and PUSH IN connection
- Standard and low heights

### General ordering data

Type	FS 2CO	Version
Order No.	<a href="#">7760056106</a>	D-SERIES DRM, Relay socket, Number of contacts: 2, CO contact,
GTIN (EAN)	4032248855582	Continuous current: 12 A, Screw connection
Qty.	10 ST	
Type	FS 4CO	Version
Order No.	<a href="#">7760056107</a>	D-SERIES DRM, Relay socket, Number of contacts: 4, CO contact,
GTIN (EAN)	4032248855575	Continuous current: 10 A, Screw connection
Qty.	10 ST	
Type	SCM 2CO ECO	Version
Order No.	<a href="#">7760056263</a>	D-SERIES DRM, Relay socket, Number of contacts: 2, CO contact,
GTIN (EAN)	6944169662966	Continuous current: 12 A, Screw connection
Qty.	10 ST	
Type	SCM 4CO ECO	Version
Order No.	<a href="#">7760056264</a>	D-SERIES DRM, Relay socket, Number of contacts: 4, CO contact,
GTIN (EAN)	6944169662973	Continuous current: 6 A, Screw connection
Qty.	10 ST	
Type	SCM 2CO P	Version
Order No.	<a href="#">7760056362</a>	D-SERIES DRM, Relay socket, Number of contacts: 2, CO contact,
GTIN (EAN)	6944169772269	Continuous current: 12 A, PUSH IN
Qty.	10 ST	
Type	SCM 4CO P	Version
Order No.	<a href="#">7760056363</a>	D-SERIES DRM, Relay socket, Number of contacts: 4, CO contact,
GTIN (EAN)	6944169772276	Continuous current: 6 A, PUSH IN
Qty.	10 ST	

### Retaining clips



Retaining clip for D-SERIES DRM relays

- Metal and plastic retaining clip

## DRM270110LT

**Weidmüller Interface GmbH & Co. KG**  
 Klingenbergstraße 26  
 D-32758 Detmold  
 Germany

www.weidmueller.com

## Accessories

## General ordering data

Type	DRM/DRL CLIP M	Version
Order No.	<a href="#">7760056108</a>	D-SERIES, Retaining clip
GTIN (EAN)	4032248855568	
Qty.	10 ST	
Type	SCM CLIP P	Version
Order No.	<a href="#">7760056367</a>	D-SERIES DRM, Retaining clip
GTIN (EAN)	6944169773334	
Qty.	5 ST	

## Protection modules



Pluggable protective modules for the D-SERIES relay sockets, with optional protective functions.

- With free-wheeling diode or RC filter

## General ordering data

Type	RIM 1 6/230VDC	Version
Order No.	<a href="#">7760056169</a>	D-SERIES, Free-wheeling diode, Rated control voltage: 6...230 V, Plug-
GTIN (EAN)	4032248967728	in connection
Qty.	10 ST	

## LED



Pluggable protective modules for the D-SERIES relay sockets, with optional protective functions.

- With green LED

## General ordering data

Type	RIM 3 110/230VUC	Version
Order No.	<a href="#">7940018455</a>	D-SERIES, LED module, Rated control voltage: 110...230 V UC, Plug-
GTIN (EAN)	4032248878185	in connection
Qty.	10 ST	

## DRM270110LT

**Weidmüller Interface GmbH & Co. KG**  
 Klingenbergstraße 26  
 D-32758 Detmold  
 Germany

www.weidmueller.com

## Accessories

### LED / free-wheel diode



Pluggable protective modules for the D-SERIES relay sockets, with optional protective functions.

- With green LED and free-wheeling diode

### General ordering data

Type	RIM 2 110/230VDC	Version	
Order No.	<a href="#">7760056017</a>	D-SERIES, LED module with freewheel diode, Rated control voltage:	
GTIN (EAN)	4032248896615	110...230 V DC, Plug-in connection	
Qty.	10 ST		

### Blank

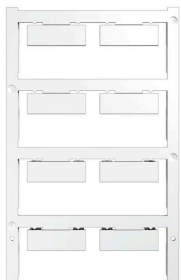

ESG is the tried-and-tested marker in MultiCard format for use on many well-known electrical devices. The result is high-quality device marking with a high-contrast appearance.

Various types are available for devices from manufacturers like Siemens, ABB, Beckhoff etc.

Advantages at a glance:

- Tags for universal usage, self-adhesive or clip-on tags, depending on type
- For aligned equipment, e.g. circuit breakers, we supply ESG markers for clipping onto tag rails
- Individual laser-quality printing according to specifications

For custom printing: Please send us a file of our labeling software M-Print PRO or M-Print PRO Online (without installation) for your labeling specifications.

### General ordering data

Type	ESG 9/26 SCM ECO MC NE ...	Version	
Order No.	<a href="#">1520980000</a>	ESG, Device markers x 26 mm, PA 66, Colour: white, pluggable	
GTIN (EAN)	4050118327939		
Qty.	80 ST		
Type	ESG 9/26 SCM ECO MC NE ...	Version	
Order No.	<a href="#">1521000000</a>	ESG, Device markers x 26 mm, PA 66, Colour: grey, pluggable	
GTIN (EAN)	4050118327878		
Qty.	80 ST		
Type	ESG 9/26 SCM ECO MC NE ...	Version	
Order No.	<a href="#">1520990000</a>	ESG, Device markers x 26 mm, PA 66, Colour: yellow, pluggable	
GTIN (EAN)	4050118327861		
Qty.	80 ST		

## DRM270110LT

**Weidmüller Interface GmbH & Co. KG**

Klingenbergstraße 26

D-32758 Detmold

Germany

[www.weidmueller.com](http://www.weidmueller.com)

## Accessories

### Custom printing

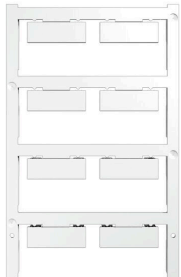

ESG is the tried-and-tested marker in MultiCard format for use on many well-known electrical devices. The result is high-quality device marking with a high-contrast appearance.

Various types are available for devices from manufacturers like Siemens, ABB, Beckhoff etc.

Advantages at a glance:

- Tags for universal usage, self-adhesive or clip-on tags, depending on type
- For aligned equipment, e.g. circuit breakers, we supply ESG markers for clipping onto tag rails
- Individual laser-quality printing according to specifications

For custom printing: Please send us a file of our labeling software M-Print PRO or M-Print PRO Online (without installation) for your labeling specifications.

### General ordering data

Type	ESG 9/26 SCM ECO MC SDR	Version	
Order No.	<a href="#">1525800000</a>	ESG, Device markers x 26 mm, PA 66, Colour: To customer	
GTIN (EAN)	4050118331875	specification, pluggable	
Qty.	16 ST		

### Blank

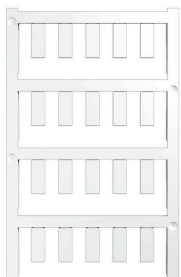

ESG is the tried-and-tested marker in MultiCard format for use on many well-known electrical devices. The result is high-quality device marking with a high-contrast appearance.

Various types are available for devices from manufacturers like Siemens, ABB, Beckhoff etc.

Advantages at a glance:

- Tags for universal usage, self-adhesive or clip-on tags, depending on type
- For aligned equipment, e.g. circuit breakers, we supply ESG markers for clipping onto tag rails
- Individual laser-quality printing according to specifications

For custom printing: Please send us a file of our labeling software M-Print PRO or M-Print PRO Online (without installation) for your labeling specifications.

### General ordering data

Type	ESG 6/15 K MC NE WS	Version	
Order No.	<a href="#">1880100000</a>	ESG, Device markers x 15 mm, PA 66, Colour: white, Self-adhesive	
GTIN (EAN)	4032248478781		
Qty.	200 ST		
Type	ESG 6/15 K MC NE GE	Version	
Order No.	<a href="#">1880130000</a>	ESG, Device markers x 15 mm, PA 66, Colour: yellow, Self-adhesive	
GTIN (EAN)	4032248478910		
Qty.	200 ST		

## DRM270110LT

**Weidmüller Interface GmbH & Co. KG**  
 Klingenbergstraße 26  
 D-32758 Detmold  
 Germany

www.weidmueller.com

## Accessories

Type	ESG 6/17 K MC NE GE	Version
Order No.	<a href="#">1880110000</a>	ESG, Device markers x 17 mm, PA 66, Colour: yellow, Self-adhesive
GTIN (EAN)	4032248478798	
Qty.	200 ST	
Type	ESG 6/17 K MC NE WS	Version
Order No.	<a href="#">1880120000</a>	ESG, Device markers x 17 mm, PA 66, Colour: white, Self-adhesive
GTIN (EAN)	4032248478804	
Qty.	200 ST	

### ESG 6/15



Guaranteed long service life: ESG

The multi-colour and multi-format labels have a strong adhesive layer to ensure the best possible adhesion to the underlying surface. Double laminated polyester makes the basic material very thin and yet extremely tear-resistant.

Your benefits with MultiMark

- "Different materials for various requirements"
- Can be used with equipment from many manufacturers
- Device markers with a familiar design

#### General ordering data

Type	ESG 6/15 MM WS	Version
Order No.	<a href="#">2619940000</a>	ESG, Device markers, 6 x 15 mm, white
GTIN (EAN)	4050118626148	
Qty.	3000 ST	

### ESG 6/17



Guaranteed long service life: ESG

The multi-colour and multi-format labels have a strong adhesive layer to ensure the best possible adhesion to the underlying surface. Double laminated polyester makes the basic material very thin and yet extremely tear-resistant.

Your benefits with MultiMark

- "Different materials for various requirements"
- Can be used with equipment from many manufacturers
- Device markers with a familiar design

#### General ordering data

Type	ESG 6/17 MM WS	Version
Order No.	<a href="#">2005100000</a>	ESG, Device markers, 6 x 17 mm, white
GTIN (EAN)	4050118390728	
Qty.	3000 ST	

## DRM270110LT

Weidmüller Interface GmbH &amp; Co. KG

Klingenbergstraße 26

D-32758 Detmold

Germany

www.weidmueller.com

## Counterpart

## Sockets



Relay sockets for the D-SERIES DRM relays

- 2 and 4 CO contacts
- Screw and PUSH IN connection
- Standard and low heights

## General ordering data

Type	SCM 2CO ECO	Version
Order No.	<a href="#">7760056263</a>	D-SERIES DRM, Relay socket, Number of contacts: 2, CO contact,
GTIN (EAN)	6944169662966	Continuous current: 12 A, Screw connection
Qty.	10 ST	
Type	SCM 4CO ECO	Version
Order No.	<a href="#">7760056264</a>	D-SERIES DRM, Relay socket, Number of contacts: 4, CO contact,
GTIN (EAN)	6944169662973	Continuous current: 6 A, Screw connection
Qty.	10 ST	
Type	FS 2CO	Version
Order No.	<a href="#">7760056106</a>	D-SERIES DRM, Relay socket, Number of contacts: 2, CO contact,
GTIN (EAN)	4032248855582	Continuous current: 12 A, Screw connection
Qty.	10 ST	
Type	FS 4CO	Version
Order No.	<a href="#">7760056107</a>	D-SERIES DRM, Relay socket, Number of contacts: 4, CO contact,
GTIN (EAN)	4032248855575	Continuous current: 10 A, Screw connection
Qty.	10 ST	
Type	SCM 2CO P	Version
Order No.	<a href="#">7760056362</a>	D-SERIES DRM, Relay socket, Number of contacts: 2, CO contact,
GTIN (EAN)	6944169772269	Continuous current: 12 A, PUSH IN
Qty.	10 ST	
Type	SCM 4CO P	Version
Order No.	<a href="#">7760056363</a>	D-SERIES DRM, Relay socket, Number of contacts: 4, CO contact,
GTIN (EAN)	6944169772276	Continuous current: 6 A, PUSH IN
Qty.	10 ST	