

## BCL-SMT 3.81/06/180 1.5SN BK BX

**Weidmüller Interface GmbH & Co. KG**  
 Klingenbergstraße 26  
 D-32758 Detmold  
 Germany

www.weidmueller.com

### Product image

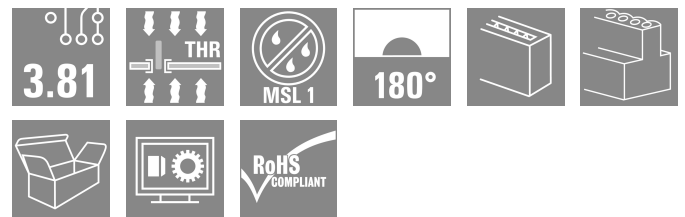
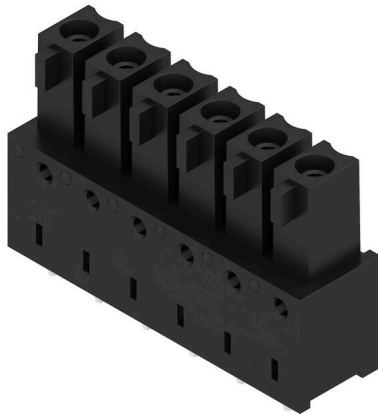

The inverted BCL-SMT socket block for the PCB offers three significant advantages:

- The BCL-SMT offers touch-safe security on the PCB which makes it ideal for live, current-carrying outputs.
- The BCL-SMT widens the range of applications with board-to-board connections between component assemblies.
- The BCL-SMT is reflow-compatible and can be seamlessly integrated into the automatic assembly and soldering process.

Two outlet directions give you a choice of position and thus more design flexibility.

- 180° standing
- 90° recumbent

Two housing variants are available for the BCL-SMT:

- Without flange
- With inverted solder flange ("LFI", with nut)
  - Fastened to PCB without additional screw
  - Fastened with screw to the SCZ FI

Weidmüller's 3.81-mm-pitch (0.15 inch) plug-in connectors are compatible with the layouts of customary connectors and offer space for labelling and coding.

### General ordering data

Version	PCB plug-in connector, female header, closed side, THT/THR solder connection, 3.81 mm, Number of poles: 6, 180°, Solder pin length (l): 1.5 mm, tinned, black, Box
Order No.	<a href="#">1976550000</a>
Type	BCL-SMT 3.81/06/180 1.5SN BK BX
GTIN (EAN)	4032248679027
Qty.	50 items
Product data	IEC: 320 V / 17.5 A UL: 300 V / 10 A
Packaging	Box

## BCL-SMT 3.81/06/180 1.5SN BK BX

Weidmüller Interface GmbH & Co. KG  
Klingenbergstraße 26  
D-32758 Detmold  
Germany

www.weidmueller.com

## Technical data

## Approvals

Approvals



ROHS	Conform
UL File Number Search	<a href="#">UL Website</a>
Certificate No. (cURus)	E60693

## Dimensions and weights

Net weight	2.72 g
------------	--------

## Environmental Product Compliance

RoHS Compliance Status	Compliant without exemption
REACH SVHC	No SVHC above 0.1 wt%

## System specifications

Product family	OMNIMATE Signal - series BC/SC 3.81	Type of connection	Board connection
Mounting onto the PCB	THT/THR solder connection	Pitch in mm (P)	3.81 mm
Pitch in inches (P)	0.150 "	Outgoing elbow	180°
Number of poles	6	Number of solder pins per pole	2
Solder pin length (l)	1.5 mm	Solder pin length tolerance	0 / -0,02 mm
Solder pin dimensions	d = 0.8 mm	Solder pin dimensions = d tolerance	+0,05 / -0,05 mm
Solder eyelet hole diameter (D)	1.2 mm	Solder eyelet hole diameter tolerance (D)	+ 0,1 mm
Outside diameter of solder pad	1.9 mm	Template aperture diameter	1.6 mm
L1 in mm	19.05 mm	L1 in inches	0.750 "
Number of rows	1	Pin series quantity	1
Touch-safe protection acc. to DIN VDE 57 106	Safe from back-of-hand touch	Touch-safe protection acc. to DIN VDE 0470	IP20 plugged
Volume resistance	≤5 mΩ	Can be coded	Yes
Plugging force/pole, max.	9.5 N	Pulling force/pole, max.	6 N

## Material data

Insulating material	LCP GF	Colour	black
Colour chart (similar)	RAL 9011	Insulating material group	IIla
Comparative Tracking Index (CTI)	≥ 175	Moisture Level (MSL)	1
UL 94 flammability rating	V-0	Contact material	Cu-alloy
Contact surface	tinned	Layer structure of solder connection	1...3 μm Ni / 2...4 μm Sn matt
Layer structure of plug contact	1...3 μm Ni / 2...4 μm Sn matt	Storage temperature, min.	-40 °C
Storage temperature, max.	70 °C	Operating temperature, min.	-50 °C
Operating temperature, max.	120 °C	Temperature range, installation, min.	-25 °C
Temperature range, installation, max.	120 °C		

## Rated data acc. to IEC

tested acc. to standard	IEC 60664-1, IEC 61984	Rated current, min. number of poles (Tu=20°C)	17.5 A
Rated current, max. number of poles (Tu=20°C)	15.4 A	Rated current, min. number of poles (Tu=40°C)	17.5 A

## BCL-SMT 3.81/06/180 1.5SN BK BX

**Weidmüller Interface GmbH & Co. KG**  
 Klingenbergstraße 26  
 D-32758 Detmold  
 Germany

www.weidmueller.com

### Technical data

Rated current, max. number of poles (Tu=40°C)	13.8 A	Rated voltage for surge voltage class / pollution degree II/2	320 V
Rated voltage for surge voltage class / pollution degree III/2	160 V	Rated voltage for surge voltage class / pollution degree III/3	160 V
Rated impulse voltage for surge voltage class/ pollution degree II/2	2.5 kV	Rated impulse voltage for surge voltage class/ pollution degree III/2	2.5 kV
Rated impulse voltage for surge voltage class/ contamination degree III/3	2.5 kV	Short-time withstand current resistance	3 x 1s with 76 A

#### Rated data acc. to CSA

Rated voltage (Use group B / CSA)	300 V	Rated voltage (Use group C / CSA)	50 V
Rated current (Use group B / CSA)	11 A	Rated current (Use group C / CSA)	11 A

#### Rated data acc. to UL 1059

Institute (cURus)	CURUS	Certificate No. (cURus)	E60693
Rated voltage (Use group B / UL 1059)	300 V	Rated voltage (Use group D / UL 1059)	300 V
Rated current (Use group B / UL 1059)	10 A	Rated current (Use group D / UL 1059)	10 A
Reference to approval values	Specifications are maximum values, details - see approval certificate.		

#### Packing

Packaging	Box	VPE length	22.00 mm
VPE width	118.00 mm	VPE height	135.00 mm

#### Important note

IPC conformity	Conformity: The products are developed, manufactured and delivered according international recognized standards and norms and comply with the assured properties in the data sheet resp. fulfill decorative properties in accordance with IPC-A-610 "Class 2". Further claims on the products can be evaluated on request.
Notes	<ul style="list-style-type: none"> <li>Rated current related to rated cross-section &amp; min. No. of poles.</li> <li>P on drawing = pitch</li> <li>Rated data refer only to the component itself. Clearance and creepage distances to other components are to be designed in accordance with the relevant application standards.</li> <li>In accordance with IEC 61984, OMNIMATE-connectors are connectors without breaking capacity (COC). During designated use, connectors are not allowed to be engaged or disengaged when live or under load</li> <li>Long term storage of the product with average temperature of 50 °C and maximum humidity 70%, 36 months</li> </ul>

#### Classifications

ETIM 8.0	EC002637	ETIM 9.0	EC002637
ETIM 10.0	EC002637	ECLASS 14.0	27-46-02-01
ECLASS 15.0	27-46-02-01		

**BCL-SMT 3.81/06/180 1.5SN BK BX**

**Weidmüller Interface GmbH & Co. KG**  
 Klingenbergstraße 26  
 D-32758 Detmold  
 Germany

Drawings

www.weidmueller.com

Product image



Dimensional drawing

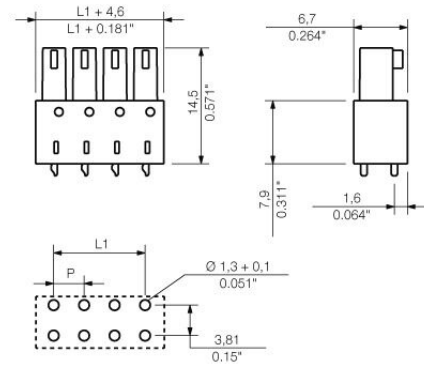

Graph



Graph



## BCL-SMT 3.81/06/180 1.5SN BK BX

**Weidmüller Interface GmbH & Co. KG**  
 Klingenbergstraße 26  
 D-32758 Detmold  
 Germany

www.weidmueller.com

## Counterpart

### SC 3.81/135G



The SC pin header with 135° wire outlet direction: the 135° angle exists between the plugging direction and the solder pin. The wire outlet direction is then diagonal or 45° to the PCB.

- More freedom when designing components and devices.
- Easy access and a high component density when multiple interfaces are arranged in parallel within a single plugging area
- The housing design is application-friendly because of the additional optional wire outlet direction.
- Available in closed (G) and screw flange (F) versions. Weidmüller's 3.81-mm-pitch (0.15 inch) plug-in connectors are compatible with the layouts of standard connectors and offer space for labelling and coding.

#### General ordering data

Type	SC 3.81/06/135G 3.2SN B...	Version
Order No.	<a href="#">1976460000</a>	PCB plug-in connector, male header, closed side, THT solder connection, 3.81 mm, Number of poles: 6, 135°, Solder pin length (l):
GTIN (EAN)	4032248683055	3.2 mm, tinned, black, Box
Qty.	50 ST	
Type	SC 3.81/06/135G 3.2SN G...	Version
Order No.	<a href="#">1976060000</a>	PCB plug-in connector, male header, closed side, THT solder connection, 3.81 mm, Number of poles: 6, 135°, Solder pin length (l):
GTIN (EAN)	4032248684397	3.2 mm, tinned, Pale green, Box
Qty.	50 ST	
Type	SC 3.81/06/135G 3.2SN O...	Version
Order No.	<a href="#">1975880000</a>	PCB plug-in connector, male header, closed side, THT solder connection, 3.81 mm, Number of poles: 6, 135°, Solder pin length (l):
GTIN (EAN)	4032248684199	3.2 mm, tinned, orange, Box
Qty.	50 ST	

### SC 3.81/180G

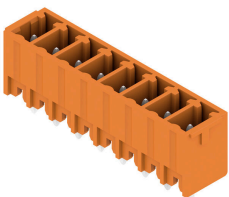

The SC pin header has a perpendicular (standing) plugging direction in relation to the PCB. It is available in closed (G) and screw flange (F) versions.

Weidmüller's 3.81-mm-pitch (0.15 inch) plug-in connectors are compatible with the layouts of standard connectors and offer space for labelling and coding.

#### General ordering data

Type	SC 3.81/06/180G 3.2SN O...	Version
Order No.	<a href="#">1942880000</a>	PCB plug-in connector, male header, closed side, THT solder connection, 3.81 mm, Number of poles: 6, 180°, Solder pin length (l):
GTIN (EAN)	4032248654710	3.2 mm, tinned, orange, Box
Qty.	72 ST	
Type	SC 3.81/06/180G 3.2SN G...	Version
Order No.	<a href="#">1793650000</a>	PCB plug-in connector, male header, closed side, THT solder connection, 3.81 mm, Number of poles: 6, 180°, Solder pin length (l):
GTIN (EAN)	4032248230778	3.2 mm, tinned, Pale green, Box
Qty.	72 ST	

## BCL-SMT 3.81/06/180 1.5SN BK BX

**Weidmüller Interface GmbH & Co. KG**  
 Klingenbergstraße 26  
 D-32758 Detmold  
 Germany

www.weidmueller.com

## Counterpart

Type	SC 3.81/06/180G 3.2SN B...	Version
Order No.	<a href="#">1793560000</a>	PCB plug-in connector, male header, closed side, THT solder
GTIN (EAN)	4032248230488	connection, 3.81 mm, Number of poles: 6, 180°, Solder pin length (l):
Qty.	50 ST	3.2 mm, tinned, black, Box

## SC 3.81/90G

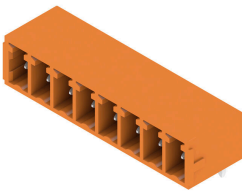

The SC pin header has a parallel (recumbent) plugging direction in relation to the PCB. It is available in closed (G) and screw flange (F) versions.

Weidmüller's 3.81-mm-pitch (0.15 inch) plug-in connectors are compatible with the layouts of standard connectors. They support a flood-light display and offer space for labelling and coding.

### General ordering data

Type	SC 3.81/06/90G 3.2SN OR...	Version
Order No.	<a href="#">1942100000</a>	PCB plug-in connector, male header, closed side, THT solder
GTIN (EAN)	4032248655489	connection, 3.81 mm, Number of poles: 6, 90°, Solder pin length (l):
Qty.	72 ST	3.2 mm, tinned, orange, Box
Type	SC 3.81/06/90G 3.2SN GN...	Version
Order No.	<a href="#">1793280000</a>	PCB plug-in connector, male header, closed side, THT solder
GTIN (EAN)	4032248227754	connection, 3.81 mm, Number of poles: 6, 90°, Solder pin length (l):
Qty.	72 ST	3.2 mm, tinned, Pale green, Box
Type	SC 3.81/06/90G 3.2SN BK...	Version
Order No.	<a href="#">1793170000</a>	PCB plug-in connector, male header, closed side, THT solder
GTIN (EAN)	4032248227662	connection, 3.81 mm, Number of poles: 6, 90°, Solder pin length (l):
Qty.	72 ST	3.2 mm, tinned, black, Box

## SCD 3.81/90G

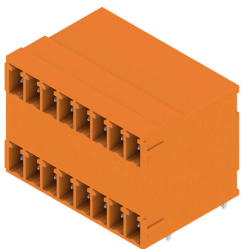

Two-tier SCD pin header for wave soldering.

- It allows you to use two interfaces on only one surface and with only one step in the work flow.
- Outlet direction: 90° (recumbent)
- Connections at the same level and with access that is flush over the front board.
- Space for labelling and coding
- Packed in cardboard box.

Weidmüller's 3.81-mm-pitch (0.15 inch) plug-in connectors are compatible with the layouts of standard connectors and offer space for labelling and coding.

### General ordering data

Type	SCD 3.81/12/90G 3.2SN B...	Version
Order No.	<a href="#">1973140000</a>	PCB plug-in connector, male header, closed side, THT solder
GTIN (EAN)	4032248682706	connection, 3.81 mm, Number of poles: 12, 90°, Solder pin length (l):
Qty.	48 ST	3.2 mm, tinned, black, Box
Type	SCD 3.81/12/90G 3.2SN G...	Version
Order No.	<a href="#">1972990000</a>	PCB plug-in connector, male header, closed side, THT solder
GTIN (EAN)	4032248682553	connection, 3.81 mm, Number of poles: 8, 90°, Solder pin length (l):
Qty.	50 ST	3.2 mm, tinned, Light green, Box

## BCL-SMT 3.81/06/180 1.5SN BK BX

**Weidmüller Interface GmbH & Co. KG**  
Klingenbergstraße 26  
D-32758 Detmold  
Germany

www.weidmueller.com

## Counterpart

Type	SCD 3.81/12/90G 3.2SN O...	Version
Order No.	<a href="#">1972830000</a>	PCB plug-in connector, male header, closed side, THT solder
GTIN (EAN)	4032248682409	connection, 3.81 mm, Number of poles: 12, 90°, Solder pin length (l):
Qty.	48 ST	3.2 mm, tinned, orange, Box

## SCD 3.81/180G

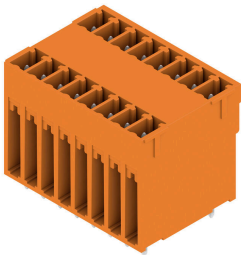

Two-tier SCD pin header for wave soldering.

- It allows you to use two interfaces on only one surface and with only one step in the work flow.
- Outlet direction: 180° (standing).
- Connections at the same level and with access that is flush over the front board.
- Space for labelling and coding
- Packed in cardboard box.

Weidmüller's 3.81-mm-pitch (0.15 inch) plug-in connectors are compatible with the layouts of standard connectors and offer space for labelling and coding.

### General ordering data

Type	SCD 3.81/12/180G 3.2SN ...	Version
Order No.	<a href="#">1030310000</a>	PCB plug-in connector, male header, closed side, THT solder
GTIN (EAN)	4032248759477	connection, 3.81 mm, Number of poles: 12, 180°, Solder pin length
Qty.	48 ST	(l): 3.2 mm, tinned, black, Box
Type	SCD 3.81/12/180G 3.2SN ...	Version
Order No.	<a href="#">1029970000</a>	PCB plug-in connector, male header, closed side, THT solder
GTIN (EAN)	4032248759071	connection, 3.81 mm, Number of poles: 12, 180°, Solder pin length
Qty.	48 ST	(l): 3.2 mm, tinned, orange, Box

## SC 3.81/270G

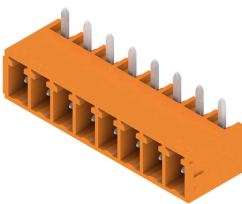

The SC pin header in 270°-outlet direction: the 270° angle exists between the plugging direction and the solder pin. The plugging direction is then parallel to the PCB. Sockets blocks, however, have an overhead plugging angle.

- More freedom when designing components and devices.
- A high component density when multiple PCBs are arranged in parallel within one housing
- The housing design is application-friendly because of the additional optional wire outlet direction.
- Available in closed (G) and screw flange (F) versions.

Weidmüller's 3.81-mm-pitch (0.15 inch) plug-in connectors are compatible with the layouts of standard connectors and offer space for labelling and coding.

### General ordering data

Type	SC 3.81/06/270G 3.2SN B...	Version
Order No.	<a href="#">1037920000</a>	PCB plug-in connector, male header, closed side, THT solder
GTIN (EAN)	4032248766468	connection, 3.81 mm, Number of poles: 6, 270°, Solder pin length (l):
Qty.	50 ST	3.2 mm, tinned, black, Box

## BCL-SMT 3.81/06/180 1.5SN BK BX

**Weidmüller Interface GmbH & Co. KG**  
Klingenbergstraße 26  
D-32758 Detmold  
Germany

www.weidmueller.com

### Counterpart

Type	SC 3.81/06/270G 3.2SN G...	Version
Order No.	<a href="#">1037730000</a>	PCB plug-in connector, male header, closed side, THT solder
GTIN (EAN)	4032248766314	connection, 3.81 mm, Number of poles: 6, 270°, Solder pin length (l):
Qty.	50 ST	3.2 mm, tinned, Pale green, Box
Type	SC 3.81/06/270G 3.2SN O...	Version
Order No.	<a href="#">1037540000</a>	PCB plug-in connector, male header, closed side, THT solder
GTIN (EAN)	4032248766161	connection, 3.81 mm, Number of poles: 6, 270°, Solder pin length (l):
Qty.	50 ST	3.2 mm, tinned, orange, Box

### SCDN 3.81/90G

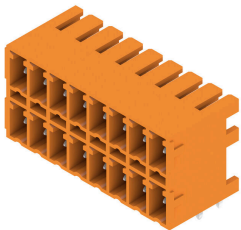

Extra flat two-tier SCDN pin header for wave soldering.

- Two compact interfaces are used with the flat BCF 3.81 (PUSH IN) socket block.
- Available as 90° (recumbent).
- Connections on a single level, allowing access that is flush over the front board.
- Space for labelling and coding
- Packed in cardboard box.

Weidmüller's 3.81-mm-pitch (0.15 inch) plug-in connectors are compatible with the layouts of standard connectors and offer space for labelling and coding.

#### General ordering data

Type	SCDN 3.81/12/90G 3.2SN ...	Version
Order No.	<a href="#">1040840000</a>	PCB plug-in connector, male header, closed side, THT solder
GTIN (EAN)	4032248769698	connection, 3.81 mm, Number of poles: 12, 90°, Solder pin length (l):
Qty.	50 ST	3.2 mm, tinned, black, Box
Type	SCDN 3.81/12/90G 3.2SN ...	Version
Order No.	<a href="#">1040450000</a>	PCB plug-in connector, male header, closed side, THT solder
GTIN (EAN)	4032248769117	connection, 3.81 mm, Number of poles: 12, 90°, Solder pin length (l):
Qty.	50 ST	3.2 mm, tinned, orange, Box

### SCDV 3.81/180G



Two-tier SCDV pin header for wave soldering.

- It allows you to use two interfaces on only one surface and with only one step in the work flow.
- Outlet direction: 180° (standing).
- Connections at two offset levels and open access to each row.
- Space for labelling and coding
- Packed in cardboard box.

Weidmüller's 3.81-mm-pitch (0.15 inch) plug-in connectors are compatible with the layouts of standard connectors and offer space for labelling and coding.

#### General ordering data

Type	SCDV 3.81/12/180G 3.2SN...	Version
Order No.	<a href="#">1034530000</a>	PCB plug-in connector, male header, closed side, THT solder
GTIN (EAN)	4032248763351	connection, 3.81 mm, Number of poles: 12, 180°, Solder pin length
Qty.	50 ST	(l): 3.2 mm, tinned, orange, Box

## BCL-SMT 3.81/06/180 1.5SN BK BX

Weidmüller Interface GmbH & Co. KG  
Klingenbergstraße 26  
D-32758 Detmold  
Germany

## Counterpart

www.weidmueller.com

## SCDV 3.81/90G

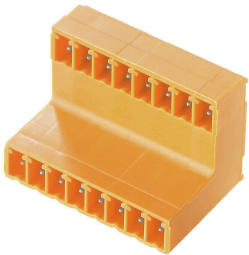

Two-tier SCDV pin header for wave soldering.

- It allows you to use two interfaces on only one surface and with only one step in the work flow.
- Outlet direction: 90° (recumbent)
- Connections at two offset levels and with open access to each row.
- Space for labelling and coding
- Packed in cardboard box.

Weidmüller's 3.81-mm-pitch (0.15 inch) plug-in connectors are compatible with the layouts of standard connectors and offer space for labelling and coding.

## General ordering data

Type	SCDV 3.81/12/90G 3.2SN ...	Version
Order No.	<a href="#">1032470000</a>	PCB plug-in connector, male header, closed side, THT solder
GTIN (EAN)	4032248771745	connection, 3.81 mm, Number of poles: 12, 90°, Solder pin length (l):
Qty.	50 ST	3.2 mm, tinned, black, Box
Type	SCDV 3.81/12/90G 3.2SN ...	Version
Order No.	<a href="#">1032140000</a>	PCB plug-in connector, male header, closed side, THT solder
GTIN (EAN)	4032248771448	connection, 3.81 mm, Number of poles: 12, 90°, Solder pin length (l):
Qty.	50 ST	3.2 mm, tinned, orange, Box

## SCD-THR 3.81/90G



High-temperature-resistant two-tier SCD-THR pin header for reflow soldering.

- It allows you to use two interfaces on only one surface and with only one step in the work flow.
- Outlet direction: 90° (recumbent)
- Connections at the same level and with access that is flush over the front board.
- Space for labelling and coding
- Packed in cardboard box.

Weidmüller's 3.81-mm-pitch (0.15 inch) plug-in connectors are compatible with the layouts of standard connectors and offer space for labelling and coding.

## General ordering data

Type	SCD-THR 3.81/12/90G 1.5...	Version
Order No.	<a href="#">1974070000</a>	PCB plug-in connector, male header, closed side, THT/THR solder
GTIN (EAN)	4032248683581	connection, 3.81 mm, Number of poles: 12, 90°, Solder pin length (l):
Qty.	50 ST	1.5 mm, tinned, black, Box
Type	SCD-THR 3.81/12/90G 3.2...	Version
Order No.	<a href="#">1973770000</a>	PCB plug-in connector, male header, closed side, THT/THR solder
GTIN (EAN)	4032248683284	connection, 3.81 mm, Number of poles: 12, 90°, Solder pin length (l):
Qty.	50 ST	3.2 mm, tinned, black, Box

## BCL-SMT 3.81/06/180 1.5SN BK BX

**Weidmüller Interface GmbH & Co. KG**  
 Klingenbergstraße 26  
 D-32758 Detmold  
 Germany

## Counterpart

www.weidmueller.com

### SC-SMT 3.81/90G Box



High-temperature-resistant pin header (SC-SMT 90G) in 3.81-mm pitch (0.15 inch)

- Plugging direction parallel to PCB (recumbent)
  - Closed (G)
  - Packed either in box (BX) or on anti-static roll (tape-on-reel, RL)
  - Pin length of either 1.5 mm or 3.2 mm
- Weidmüller's 3.81-mm-pitch (0.15 inch) plug-in connectors are compatible with the layouts of standard connectors and offer space for labelling and coding.

#### General ordering data

Type	SC-SMT 3.81/06/90G 1.5S...	Version
Order No.	<a href="#">1863000000</a>	PCB plug-in connector, male header, closed side, THT/THR solder connection, 3.81 mm, Number of poles: 6, 90°, Solder pin length (l):
GTIN (EAN)	4032248428106	1.5 mm, tinned, black, Box
Qty.	50 ST	
Type	SC-SMT 3.81/06/90G 3.2S...	Version
Order No.	<a href="#">1862510000</a>	PCB plug-in connector, male header, closed side, THT/THR solder connection, 3.81 mm, Number of poles: 6, 90°, Solder pin length (l):
GTIN (EAN)	4032248427642	3.2 mm, tinned, black, Box
Qty.	50 ST	

### SC-SMT 3.81/90G Tape

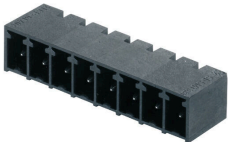

High-temperature-resistant pin header (SC-SMT 90G) in 3.81-mm pitch (0.15 inch)

- Plugging direction parallel to PCB (recumbent)
  - Closed (G)
  - Packed either in box (BX) or on anti-static roll (tape-on-reel, RL)
  - Pin length of either 1.5 mm or 3.2 mm
- Weidmüller's 3.81-mm-pitch (0.15 inch) plug-in connectors are compatible with the layouts of standard connectors and offer space for labelling and coding.

#### General ordering data

Type	SC-SMT 3.81/06/90G 1.5S...	Version
Order No.	<a href="#">1863180000</a>	PCB plug-in connector, male header, closed side, THT/THR solder connection, 3.81 mm, Number of poles: 6, 90°, Solder pin length (l):
GTIN (EAN)	4032248428373	1.5 mm, tinned, black, Tape
Qty.	400 ST	
Type	SC-SMT 3.81/06/90G 3.2S...	Version
Order No.	<a href="#">1862880000</a>	PCB plug-in connector, male header, closed side, THT/THR solder connection, 3.81 mm, Number of poles: 6, 90°, Solder pin length (l):
GTIN (EAN)	4032248428014	3.2 mm, tinned, black, Tape
Qty.	400 ST	

**BCL-SMT 3.81/06/180 1.5SN BK BX**

**Weidmüller Interface GmbH & Co. KG**  
 Klingenbergstraße 26  
 D-32758 Detmold  
 Germany

www.weidmueller.com

**Counterpart****SC-SMT 3.81/180G Box**

High-temperature-resistant pin header (SC-SMT 180G) in 3.81-mm pitch (0.15 inch)

- Plugging direction is perpendicular to PCB (standing)
- Closed (G) .
- Packed either in box (BX) or on anti-static roll (tape-on-reel, RL)

• Pin length of either 1.5 mm or 3.2 mm  
 Weidmüller's 3.81-mm-pitch (0.15 inch) plug-in connectors are compatible with the layouts of standard connectors and offer space for labelling and coding.

**General ordering data**

Type	SC-SMT 3.81/06/180G 1.5...	Version
Order No.	<a href="#">1863830000</a>	PCB plug-in connector, male header, closed side, THT/THR solder connection, 3.81 mm, Number of poles: 6, 180°, Solder pin length (l):
GTIN (EAN)	4032248428946	1.5 mm, tinned, black, Box
Qty.	50 ST	
Type	SC-SMT 3.81/06/180G 3.2...	Version
Order No.	<a href="#">1863020000</a>	PCB plug-in connector, male header, closed side, THT/THR solder connection, 3.81 mm, Number of poles: 6, 180°, Solder pin length (l):
GTIN (EAN)	4032248428151	3.2 mm, tinned, black, Box
Qty.	50 ST	

**SC-SMT 3.81/180G Tape**

High-temperature-resistant pin header (SC-SMT 180G) in 3.81-mm pitch (0.15 inch)

- Plugging direction is perpendicular to PCB (standing)
- Closed (G) .
- Packed either in box (BX) or on anti-static roll (tape-on-reel, RL)

• Pin length of either 1.5 mm or 3.2 mm  
 Weidmüller's 3.81-mm-pitch (0.15 inch) plug-in connectors are compatible with the layouts of standard connectors and offer space for labelling and coding.

**General ordering data**

Type	SC-SMT 3.81/06/180G 1.5...	Version
Order No.	<a href="#">1864310000</a>	PCB plug-in connector, male header, closed side, THT/THR solder connection, 3.81 mm, Number of poles: 6, 180°, Solder pin length (l):
GTIN (EAN)	4032248429387	1.5 mm, tinned, black, Tape
Qty.	300 ST	

## BCL-SMT 3.81/06/180 1.5SN BK BX

**Weidmüller Interface GmbH & Co. KG**  
 Klingenbergstraße 26  
 D-32758 Detmold  
 Germany

www.weidmueller.com

## Counterpart

### SCDN-THR 3.81/90G

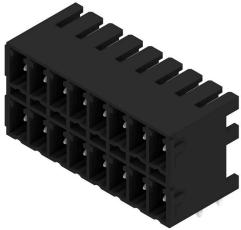

Extra flat high-temperature-resistant two-tier SCDN-THR pin header for reflow soldering.

- Two compact interfaces are used with the flat BCF 3.81 (PUSH IN) socket block.
- Available as 90° (recumbent).
- Connections on a single level, allowing access that is flush over the front board.
- Space for labelling and coding
- Packed in cardboard box.

Weidmüller's 3.81-mm-pitch (0.15 inch) plug-in connectors are compatible with the layouts of standard connectors and offer space for labelling and coding.

#### General ordering data

Type	SCDN-THR 3.81/12/90G 1...	Version
Order No.	<a href="#">1039310000</a>	PCB plug-in connector, male header, closed side, THT/THR solder
GTIN (EAN)	4032248772636	connection, 3.81 mm, Number of poles: 12, 90°, Solder pin length (l):
Qty.	50 ST	1.5 mm, tinned, black, Box
Type	SCDN-THR 3.81/12/90G 3...	Version
Order No.	<a href="#">1038990000</a>	PCB plug-in connector, male header, closed side, THT/THR solder
GTIN (EAN)	4032248772339	connection, 3.81 mm, Number of poles: 12, 90°, Solder pin length (l):
Qty.	50 ST	3.2 mm, tinned, black, Box

### SCD-THR 3.81/180G



High-temperature-resistant two-tier SCD-THR pin header for reflow soldering.

- It allows you to use two interfaces on only one surface and with only one step in the work flow.
- Outlet direction: 90° (recumbent)
- Connections at the same level and with access that is flush over the front board.
- Space for labelling and coding
- Packed in cardboard box.

Weidmüller's 3.81-mm-pitch (0.15 inch) plug-in connectors are compatible with the layouts of standard connectors and offer space for labelling and coding.

#### General ordering data

Type	SCD-THR 3.81/12/180G 1...	Version
Order No.	<a href="#">1031340000</a>	PCB plug-in connector, male header, closed side, THT/THR solder
GTIN (EAN)	4032248760374	connection, 3.81 mm, Number of poles: 12, 180°, Solder pin length
Qty.	50 ST	(l): 1.5 mm, tinned, black, Box
Type	SCD-THR 3.81/12/180G 3...	Version
Order No.	<a href="#">1030990000</a>	PCB plug-in connector, male header, closed side, THT/THR solder
GTIN (EAN)	4032248760077	connection, 3.81 mm, Number of poles: 12, 180°, Solder pin length
Qty.	50 ST	(l): 3.2 mm, tinned, black, Box

## BCL-SMT 3.81/06/180 1.5SN BK BX

**Weidmüller Interface GmbH & Co. KG**  
 Klingenbergstraße 26  
 D-32758 Detmold  
 Germany

www.weidmueller.com

## Counterpart

### SC-SMT 3.81/135G

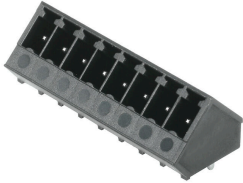

The high-temperature-resistant SC-SMT pin header with 135° wire outlet direction: the 135° angle exists between the plugging direction and the solder pin. The wire outlet direction is then diagonal or 45° to the PCB.

- More freedom when designing components and devices.
- Easy access and a high component density when multiple interfaces are arranged in parallel within a single plugging area
- The housing design is application-friendly because of the additional optional wire outlet direction.
- Available as closed (G) and with solder flange (LF).
- Pin length of either 1.5 mm or 3.2 mm

Weidmüller's 3.81-mm-pitch (0.15 inch) plug-in connectors are compatible with the layouts of standard connectors and offer space for labelling and coding.

#### General ordering data

Type	SC-SMT 3.81/06/135G 3.2...	Version
Order No.	<a href="#">1977240000</a>	PCB plug-in connector, male header, closed side, THT/THR solder
GTIN (EAN)	4032248685257	connection, 3.81 mm, Number of poles: 6, 135°, Solder pin length (l):
Qty.	50 ST	3.2 mm, tinned, black, Box

### SC-SMT 3.81/270G

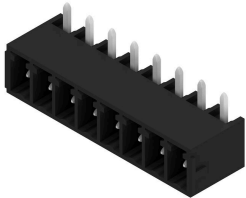

The SC-SMT pin header in 270°-outlet direction: the 270° angle exists between the plugging direction and the solder pin. The plugging direction is then parallel to the PCB. Sockets blocks, however, have an overhead plugging angle.

- More freedom when designing components and devices.
- A high component density when multiple PCBs are arranged in parallel within one housing
- The housing design is application-friendly because of the additional optional wire outlet direction.
- Available in closed (G) and screw flange (F) versions.
- Pin length of either 1.5 mm or 3.2 mm

Weidmüller's 3.81-mm-pitch (0.15 inch) plug-in connectors are compatible with the layouts of standard connectors and offer space for labelling and coding.

#### General ordering data

Type	SC-SMT 3.81/06/270G 1.5...	Version
Order No.	<a href="#">1036870000</a>	PCB plug-in connector, male header, closed side, THT/THR solder
GTIN (EAN)	4032248765454	connection, 3.81 mm, Number of poles: 6, 270°, Solder pin length (l):
Qty.	50 ST	1.5 mm, tinned, black, Box
Type	SC-SMT 3.81/06/270G 3.2...	Version
Order No.	<a href="#">1036530000</a>	PCB plug-in connector, male header, closed side, THT/THR solder
GTIN (EAN)	4032248765126	connection, 3.81 mm, Number of poles: 6, 270°, Solder pin length (l):
Qty.	50 ST	3.2 mm, tinned, black, Box

## BCL-SMT 3.81/06/180 1.5SN BK BX

**Weidmüller Interface GmbH & Co. KG**  
 Klingenbergstraße 26  
 D-32758 Detmold  
 Germany

www.weidmueller.com

## Counterpart

### SCDV-THR 3.81/180G



High-temperature-resistant two-tier SCDV-THR pin header for reflow soldering.

- It allows you to use two interfaces on only one surface and with only one step in the work flow.
- Outlet direction: 90° (recumbent)
- Connections at two offset levels and open access to each row.
- Space for labelling and coding
- Packed in cardboard box.

Weidmüller's 3.81-mm-pitch (0.15 inch) plug-in connectors are compatible with the layouts of standard connectors and offer space for labelling and coding.

#### General ordering data

Type	SCDV-THR 3.81/12/180G 1...	Version
Order No.	<a href="#">1035830000</a>	PCB plug-in connector, male header, closed side, THT/THR solder connection, 3.81 mm, Number of poles: 12, 180°, Solder pin length (l): 1.5 mm, tinned, black, Box
GTIN (EAN)	4032248764525	
Qty.	50 ST	
Type	SCDV-THR 3.81/12/180G 3...	Version
Order No.	<a href="#">1035520000</a>	PCB plug-in connector, male header, closed side, THT/THR solder connection, 3.81 mm, Number of poles: 12, 180°, Solder pin length (l): 3.2 mm, tinned, black, Box
GTIN (EAN)	4032248764273	
Qty.	50 ST	

### SCDV-THR 3.81/90G

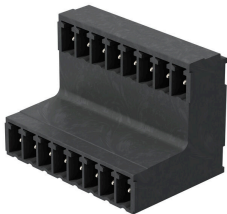

High-temperature-resistant two-tier SCDV-THR pin header for reflow soldering.

- It allows you to use two interfaces on only one surface and with only one step in the work flow.
- Outlet direction: 90° (recumbent)
- Connections at two offset levels and open access to each row.
- Space for labelling and coding
- Packed in cardboard box.

Weidmüller's 3.81-mm-pitch (0.15 inch) plug-in connectors are compatible with the layouts of standard connectors and offer space for labelling and coding.

#### General ordering data

Type	SCDV-THR 3.81/12/90G 1...	Version
Order No.	<a href="#">1033860000</a>	PCB plug-in connector, male header, closed side, THT/THR solder connection, 3.81 mm, Number of poles: 12, 90°, Solder pin length (l): 1.5 mm, tinned, black, Box
GTIN (EAN)	4032248762750	
Qty.	50 ST	
Type	SCDV-THR 3.81/12/90G 3...	Version
Order No.	<a href="#">1033540000</a>	PCB plug-in connector, male header, closed side, THT/THR solder connection, 3.81 mm, Number of poles: 12, 90°, Solder pin length (l): 3.2 mm, tinned, black, Box
GTIN (EAN)	4032248762453	
Qty.	50 ST	

## BCL-SMT 3.81/06/180 1.5SN BK BX

**Weidmüller Interface GmbH & Co. KG**  
 Klingenbergstraße 26  
 D-32758 Detmold  
 Germany

www.weidmueller.com

## Counterpart

### SCZ 3.81/180G

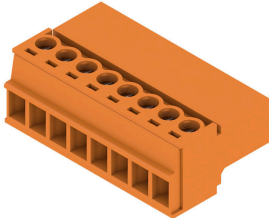

The inverted SCZ pin plug with clamping-yoke screw connection is designed for straight wire connections in 3.81-mm pitch. It can be used in two ways:

- for wire-to-wire connections together with the BCZ
- as a mating plug for the touch-safe BCL socket block on the PCB.

The SCZ is available in four different versions:

- Without flange ("G", closed)
- With standard flange ("F", with socket nut)
- With inverted flange ("FI", with screw)
- and with Weidmüller's patented release latch for a tool-free, no-strain disconnect

The SCZ provides space for labelling and can be coded.

### General ordering data

Type	SCZ 3.81/06/180G SN BK ...	Version
Order No.	<a href="#">1970060000</a>	PCB plug-in connector, male plug, 3.81 mm, Number of poles: 6,
GTIN (EAN)	4032248679478	180°, Clamping yoke connection, Clamping range, max. : 1.5 mm <sup>2</sup> ,
Qty.	50 ST	Box
Type	SCZ 3.81/06/180G SN GN ...	Version
Order No.	<a href="#">1969810000</a>	PCB plug-in connector, male plug, 3.81 mm, Number of poles: 6,
GTIN (EAN)	4032248679324	180°, Clamping yoke connection, Clamping range, max. : 1.5 mm <sup>2</sup> ,
Qty.	50 ST	Box
Type	SCZ 3.81/06/180G SN OR ...	Version
Order No.	<a href="#">1969580000</a>	PCB plug-in connector, male plug, 3.81 mm, Number of poles: 6,
GTIN (EAN)	4032248679171	180°, Clamping yoke connection, Clamping range, max. : 1.5 mm <sup>2</sup> ,
Qty.	50 ST	Box