

DRH174524LT

Weidmüller Interface GmbH & Co. KG

Klingenbergstraße 26

D-32758 Detmold

Germany

www.weidmueller.com

Product image



Similar to illustration

DRH DC relays (with blow-out magnet)

- 1 NC contact with contact series connection
- Optional AC or DC coils
- With test button and Integrated status LED

General ordering data

Version	D-SERIES DRW / DRH, Relay, Number of contacts: 1, NC contact with blow-out magnet AgSnO, Rated control voltage: 24 V AC, Continuous current: 16 A, Flat blade connections (4.8 mm x 0.5 mm), Test button available: Yes
Order No.	1219990000
Type	DRH174524LT
GTIN (EAN)	4032248998470
Qty.	10 items

Technical data

Approvals

Approvals



ROHS Conform

UL File Number Search [UL Website](#)

Certificate No. (cURus) E312083

Dimensions and weights

Depth	48 mm	Depth (inches)	1.8898 inch
Height	36 mm	Height (inches)	1.4173 inch
Width	36 mm	Width (inches)	1.4173 inch
Net weight	75.94 g		

Temperatures

Storage temperature	-40 °C...60 °C	Ambient temperature	-40 °C...60 °C
Operating temperature		Humidity	5...85 % rel. humidity, no condensation

Environmental Product Compliance

RoHS Compliance Status	Compliant without exemption
REACH SVHC	No SVHC above 0.1 wt%

Rated data UL

Certificate No. (cURus)	E312083
-------------------------	---------

Control side

Rated control voltage	24 V AC	Rated current AC	101.7 mA
Power rating	2.5 VA	Coil resistance	100 Ω ± 10 %
Status indicator	red LED		

Load side

Rated switching voltage	500 V AC	Continuous current	16 A
Max. switching frequency at rated load	0.1 Hz	Max. switching voltage, AC	400 V
Max. switching voltage, DC	300 V	Inrush current	80 A / 50 ms
AC switching capacity (resistive), max.	8000 VA	DC switching capacity (resistive), max.	2200 W @ 220 V
Switch-on delay	<20 ms	Switch-off delay	<20 ms
Contact type	1 NC contact with blow-out magnet (AgSnO)	Mechanical service life	10 x 106 switching cycles
Min. switching power	100 mA @ 12 V		

General data

Test button available	Yes		
Version of test button	Lockable test button, Momentary test button		
Mechanical switch position indicator	Yes		
Colour	Transparent		
UL94 flammability rating component	Component	Housing	
	UL94 flammability rating	V-2	
	Component	Relay baseplate	

Technical data

UL94 flammability rating	V-0
Component	Relay status indicator
UL94 flammability rating	HB
Component	Relay test button
UL94 flammability rating	HB

Insulation coordination

Insulation coordination according to	EN 61810-1:2008	Rated voltage	500 V
Pollution severity	3	Surge voltage category	III
Insulating material group	IIIa	Clearance and creepage distances for control side - load side	≥ 8 mm
Dielectric strength for control side - load side	4 kVeff / 1 min	Protection degree	IP20

Further details of approvals / standards

Certificate No. (cURus)	E312083
-------------------------	---------

Connection data

Wire connection method	Flat blade connections (4.8 mm x 0.5 mm)
------------------------	--

Classifications

ETIM 8.0	EC001437	ETIM 9.0	EC001437
ETIM 10.0	EC001437	ECLASS 14.0	27-37-16-01
ECLASS 15.0	27-37-16-01		

Drawings

Wiring diagram

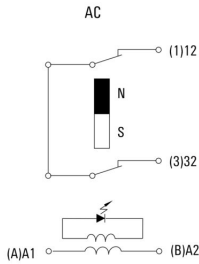

View of Pins from below

Graph



DC load limit curve Resistive load

Graph

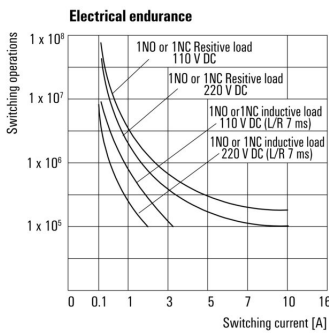

Electrical service life

Graph



AC operational voltage range

Dimensional drawing



Miscellaneous

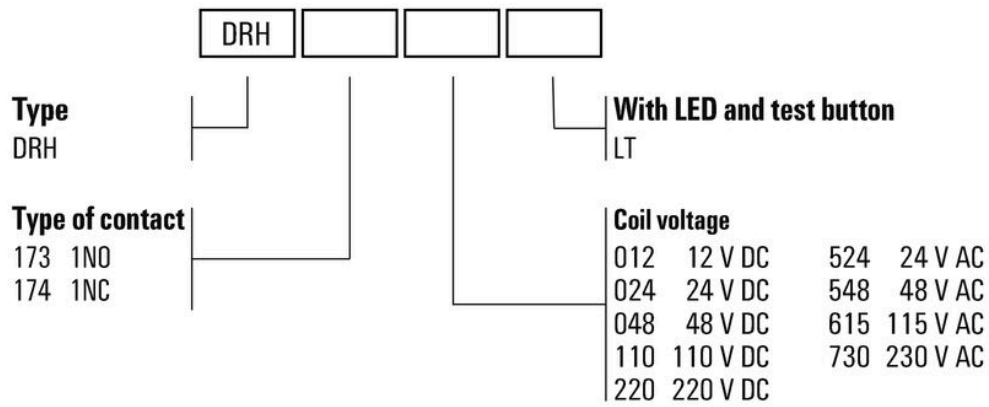

Type codes

DRH174524LT

Weidmüller Interface GmbH & Co. KG
 Klingenbergstraße 26
 D-32758 Detmold
 Germany

www.weidmueller.com

Accessories

Sockets



Relay sockets for the D-SERIES DRW/DRH relays

- Up to 3 CO contacts
- Screw connection

General ordering data

Type	SPW ECO 3CO	Version	
Order No.	1220250000	D-SERIES DRW / DRH, Relay socket, Number of contacts: 3, CO	
GTIN (EAN)	4032248100101	contact, Continuous current: 16 A, Screw connection	
Qty.	10 ST		

Protection modules



Pluggable protective modules for the D-SERIES relay sockets, with optional protective functions.

- With free-wheeling diode or RC filter

General ordering data

Type	RIM 5 6/230VAC	Version	
Order No.	1174670000	D-SERIES, RC filter, Rated control voltage: 6...230 V AC, Plug-in	
GTIN (EAN)	4032248971312	connection	
Qty.	10 ST		

Retaining clips



Retaining clip for D-SERIES DRW/DRH relays

- Metal retaining clip

General ordering data

Type	DRW/DRH CLIP M	Version	
Order No.	1220260000	D-SERIES DRW / DRH, Retaining clip	
GTIN (EAN)	4032248999576		
Qty.	10 ST		

DRH174524LT

Weidmüller Interface GmbH & Co. KG
 Klingenbergstraße 26
 D-32758 Detmold
 Germany

www.weidmueller.com

Accessories

Test button cover

Test button cover for the D-SERIES DRW/DRH relays.



General ordering data

Type	TEST LEVER BLOCK DRH/DRW	Version	
Order No.	7760056249	D-SERIES DRW / DRH, Test button cover	
GTIN (EAN)	6944 169641626		
Qty.	10 ST		

Blank



ESG is the tried-and-tested marker in MultiCard format for use on many well-known electrical devices. The result is high-quality device marking with a high-contrast appearance.

Various types are available for devices from manufacturers like Siemens, ABB, Beckhoff etc.

Advantages at a glance:

- Tags for universal usage, self-adhesive or clip-on tags, depending on type
- For aligned equipment, e.g. circuit breakers, we supply ESG markers for clipping onto tag rails
- Individual laser-quality printing according to specifications

For custom printing: Please send us a file of our labeling software M-Print PRO or M-Print PRO Online (without installation) for your labeling specifications.

General ordering data

Type	ESG 6/15 K MC NE GE	Version	
Order No.	1880130000	ESG, Device markers x 15 mm, PA 66, Colour: yellow, Self-adhesive	
GTIN (EAN)	4032248478910		
Qty.	200 ST		
Type	ESG 6/15 K MC NE WS	Version	
Order No.	1880100000	ESG, Device markers x 15 mm, PA 66, Colour: white, Self-adhesive	
GTIN (EAN)	4032248478781		
Qty.	200 ST		
Type	ESG 6/17 K MC NE GE	Version	
Order No.	1880110000	ESG, Device markers x 17 mm, PA 66, Colour: yellow, Self-adhesive	
GTIN (EAN)	4032248478798		
Qty.	200 ST		
Type	ESG 6/17 K MC NE WS	Version	
Order No.	1880120000	ESG, Device markers x 17 mm, PA 66, Colour: white, Self-adhesive	
GTIN (EAN)	4032248478804		
Qty.	200 ST		

DRH174524LT

Weidmüller Interface GmbH & Co. KG
 Klingenbergstraße 26
 D-32758 Detmold
 Germany

www.weidmueller.com

Accessories

Type	ESG 9/11 K MC NE WS	Version	
Order No.	1857440000	ESG, Device markers x 11 mm, PA 66, Colour: white, Self-adhesive	
GTIN (EAN)	4032248402731		
Qty.	200 ST		

Blank, adhesive backing



SM is a MultiCard marker for labelling control and signalling devices. The tags are clipped into the carriers or attached by means of the adhesive film already fitted to them. Customised tags can be created with the PrintJet CONNECT or Plotter marking systems.

- Users can quickly produce tags to suit their needs
- No need to stock expensive standard tags
- Highly resistant printing quality when using the PrintJet as a substitute for engraving
- For extreme demands, we recommend the ETO SM protective film
- Holders can be used for the 22-mm or 30-mm-diameter push-buttons from Siemens, ABB, Moeller and Télémécanique

For custom printing: Please send us a file of our labeling software M-Print PRO or M-Print PRO Online (without installation) for your labeling specifications.

General ordering data

Type	SM 18/9.5 K MC NE WS	Version	
Order No.	1248580000	SwitchMark, Device markers, 9.5 x 18 mm, white	
GTIN (EAN)	4050118038965		
Qty.	200 ST		
Type	SM 18/9.5 K MC NE GR	Version	
Order No.	1248610000	SwitchMark, Device markers, 9.5 x 18 mm, grey	
GTIN (EAN)	4050118038675		
Qty.	200 ST		
Type	SM 18/9.5 K MC NE GE	Version	
Order No.	1248590000	SwitchMark, Device markers, 9.5 x 18 mm, Siemens 3 SB, yellow	
GTIN (EAN)	4050118038958		
Qty.	200 ST		

ESG 6/17



Guaranteed long service life: ESG

The multi-colour and multi-format labels have a strong adhesive layer to ensure the best possible adhesion to the underlying surface. Double laminated polyester makes the basic material very thin and yet extremely tear-resistant.

Your benefits with MultiMark

- "Different materials for various requirements"
- Can be used with equipment from many manufacturers
- Device markers with a familiar design

Accessories

General ordering data

Type	ESG 6/17 MM WS	Version	
Order No.	2005100000	ESG, Device markers, 6 x 17 mm, white	
GTIN (EAN)	4050118390728		
Qty.	3000 ST		

Counterpart

Sockets



- Relay sockets for the D-SERIES DRW/DRH relays
- Up to 3 CO contacts
 - Screw connection

General ordering data

Type	SPW ECO 3CO	Version	
Order No.	1220250000	D-SERIES DRW / DRH, Relay socket, Number of contacts: 3, CO	
GTIN (EAN)	4032248100101	contact, Continuous current: 16 A, Screw connection	
Qty.	10 ST		