

BLC 5.08/02/180BR BK BX

Weidmüller Interface GmbH & Co. KG
 Klingenbergstraße 26
 D-32758 Detmold
 Germany

www.weidmueller.com

Product image

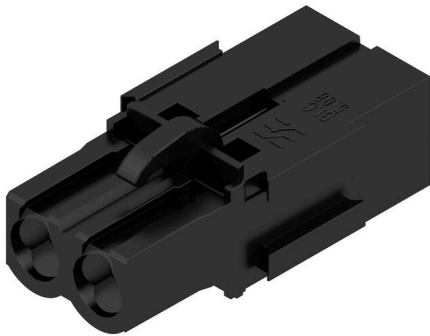

Female plugs with crimp wire connection system. The female plugs provide space for labelling and can be coded.

General ordering data

Version	PCB plug-in connector, female plug, 5.08 mm, Number of poles: 2, 180°, Crimp connection, Clamping range, max. : 2.5 mm ² , Box
Order No.	1712110000
Type	BLC 5.08/02/180BR BK BX
GTIN (EAN)	4008190935122
Qty.	100 items
Product data	IEC: 400 V / 21 A UL: 300 V / 10 A / AWG 26 - AWG 14
Packaging	Box

BLC 5.08/02/180BR BK BX

Weidmüller Interface GmbH & Co. KG
Klingenbergstraße 26
D-32758 Detmold
Germany

www.weidmueller.com

Technical data

Approvals

Approvals



ROHS	Conform
UL File Number Search	UL Website
Certificate No. (UR)	E60693

Dimensions and weights

Depth	24.5 mm	Depth (inches)	0.9646 inch
Height	10.1 mm	Height (inches)	0.3976 inch
Width	12.16 mm	Width (inches)	0.4787 inch
Net weight	1.57 g		

Environmental Product Compliance

RoHS Compliance Status	Compliant without exemption
REACH SVHC	No SVHC above 0.1 wt%

System Parameters

Product family	OMNIMATE Signal - series BL/SL 5.08	Type of connection	Field connection
Wire connection method	Crimp connection	Pitch in mm (P)	5.08 mm
Pitch in inches (P)	0.200 "	Conductor outlet direction	180°
Number of poles	2	L1 in mm	5.08 mm
L1 in inches	0.200 "	Number of rows	1
Pin series quantity	1	Rated cross-section	2.5 mm ²
Touch-safe protection acc. to DIN VDE 57 106	Safe from finger touch	Touch-safe protection acc. to DIN VDE 0470	IP20 plugged/ IP10 unplugged
Protection degree	IP20	Volume resistance	≤5 mΩ
Can be coded	Yes	Stripping length	5 mm
Plugging cycles	25	Plugging force/pole, max.	8.5 N
Pulling force/pole, max.	6.5 N		

Material data

Insulating material	PBT GF	Colour	black
Colour chart (similar)	RAL 9011	Insulating material group	Illa
Comparative Tracking Index (CTI)	≥ 200	Moisture Level (MSL)	
UL 94 flammability rating	V-0	Contact material	Cu-alloy
Layer structure of plug contact	4...8 μm Sn hot-dip tinned	Storage temperature, min.	-40 °C
Storage temperature, max.	70 °C	Operating temperature, min.	-50 °C
Operating temperature, max.	100 °C	Temperature range, installation, min.	-25 °C
Temperature range, installation, max.	100 °C		

Conductors suitable for connection

Clamping range, min.	0.22 mm ²	Clamping range, max.	2.5 mm ²
Wire connection cross section AWG, min.	AWG 24	Wire connection cross section AWG, max.	AWG 14
Flexible, min. H05(07) V-K	0.5 mm ²	Flexible, max. H05(07) V-K	2.5 mm ²
Reference text	The outside diameter of the plastic collar should not be larger than the pitch		

BLC 5.08/02/180BR BK BX

Weidmüller Interface GmbH & Co. KG
 Klingenbergstraße 26
 D-32758 Detmold
 Germany

www.weidmueller.com

Technical data

(P), Length of ferrules is to be chosen depending on the product and the rated voltage.

Rated data acc. to IEC

tested acc. to standard	IEC 60664-1, IEC 61984	Rated current, min. number of poles (Tu=20°C)	21 A
Rated current, max. number of poles (Tu=20°C)	14.5 A	Rated current, min. number of poles (Tu=40°C)	18 A
Rated current, max. number of poles (Tu=40°C)	12.5 A	Rated voltage for surge voltage class / pollution degree II/2	400 V
Rated voltage for surge voltage class / pollution degree III/2	320 V	Rated voltage for surge voltage class / pollution degree III/3	250 V
Rated impulse voltage for surge voltage class/ pollution degree II/2	4 kV	Rated impulse voltage for surge voltage class/ pollution degree III/2	4 kV
Rated impulse voltage for surge voltage class/ contamination degree III/3	4 kV	Short-time withstand current resistance	3 x 1s with 120 A

Rated data acc. to CSA

Institute (CSA)	CSA	Certificate No. (CSA)	12400-374
Rated voltage (Use group B / CSA)	300 V	Rated voltage (Use group D / CSA)	300 V
Rated current (Use group B / CSA)	10 A	Rated current (Use group D / CSA)	10 A
Wire cross-section, AWG, min.	AWG 26	Wire cross-section, AWG, max.	AWG 14
Reference to approval values	Specifications are maximum values, details - see approval certificate.		

Rated data acc. to UL 1059

Institute (UR)	UR	Certificate No. (UR)	E60693
Rated voltage (Use group B / UL 1059)	300 V	Rated voltage (Use group D / UL 1059)	300 V
Rated current (Use group B / UL 1059)	10 A	Rated current (Use group D / UL 1059)	10 A
Wire cross-section, AWG, min.	AWG 26	Wire cross-section, AWG, max.	AWG 14
Reference to approval values	Specifications are maximum values, details - see approval certificate.		

Packing

Packaging	Box	VPE length	117.00 mm
VPE width	107.00 mm	VPE height	65.00 mm

Type tests

Test: Durability of markings	Standard	draft DIN VDE 0627 section 6.2.2 / 09.91, DIN IEC 512 part 7 section 5 / 05.94
	Test	durability
	Evaluation	passed

Important note

IPC conformity	Conformity: The products are developed, manufactured and delivered according international recognized standards and norms and comply with the assured properties in the data sheet resp. fulfill decorative properties in accordance with IPC-A-610 "Class 2". Further claims on the products can be evaluated on request.
Notes	<ul style="list-style-type: none"> • Additional variants on request • Rated current related to rated cross-section & min. No. of poles. • Rated cross-section depends on crimp contact used.

BLC 5.08/02/180BR BK BX

Weidmüller Interface GmbH & Co. KG
Klingenbergstraße 26
D-32758 Detmold
Germany

www.weidmueller.com

Technical data

- P on drawing = pitch
- Rated data refer only to the component itself. Clearance and creepage distances to other components are to be designed in accordance with the relevant application standards.
- In accordance with IEC 61984, OMNIMATE-connectors are connectors without breaking capacity (COC). During designated use, connectors are not allowed to be engaged or disengaged when live or under load
- Long term storage of the product with average temperature of 50 °C and maximum humidity 70%, 36 months

Classifications

ETIM 8.0	EC002638	ETIM 9.0	EC002638
ETIM 10.0	EC002638	ECLASS 14.0	27-46-02-02
ECLASS 15.0	27-46-02-02		

BLC 5.08/02/180BR BK BX

Weidmüller Interface GmbH & Co. KG
 Klingenbergstraße 26
 D-32758 Detmold
 Germany

www.weidmueller.com

Drawings

Product image

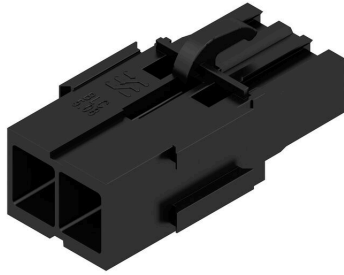

Dimensional drawing



Graph



BLC 5.08/02/180BR BK BX

Weidmüller Interface GmbH & Co. KG

Klingenbergstraße 26
D-32758 Detmold
Germany

www.weidmueller.com

Accessories

Blocks for PCB mounting



Minor component, major effect:

Clip-on attachment elements increase the mechanical resilience of the whole plug connection by

- securing the male connectors to the circuit board
- providing a vibration-proof connection between the sockets and the male connectors

Clip-on or pre-assembled - always the right solution:

- Hard-wearing, precise fitting dovetail joint
- Hard-wearing metal threaded inserts
- Suitable for all outlet directions

Maximum stability, minimum effort:

- Extremely resilient for frequent fastening operations
- Complete set for easy selection

The result: soldering points, contacts and overall module are more resilient against mechanical stress such as vibrations and tensile loads.

General ordering data

Type	SLA BB 12R SW	Version
Order No.	1626880000	PCB plug-in connector, Accessories, Mounting block, black, Number
GTIN (EAN)	4008190198213	of poles: 0
Qty.	100 ST	
Type	SLA BB 12R OR	Version
Order No.	1593450000	PCB plug-in connector, Accessories, Mounting block, orange, Number
GTIN (EAN)	4008190122164	of poles: 0
Qty.	100 ST	
Type	SLA BB 11R SW	Version
Order No.	1692340000	PCB plug-in connector, Accessories, Mounting block, black, Number
GTIN (EAN)	4008190864965	of poles: 0
Qty.	20 ST	
Type	SLA BB 11R OR	Version
Order No.	1604120000	PCB plug-in connector, Accessories, Mounting block, orange, Number
GTIN (EAN)	4008190182977	of poles: 0
Qty.	20 ST	

Coding elements

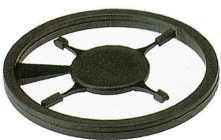

Only connects what is supposed to be connected: the right connection at the right place.

Coding elements and locking devices clearly assign connecting elements during the manufacturing process and operation

The coding elements and locking devices are inserted prior to assembly or during the cable assembly phase. The Weidmüller alternative: configure online using the variant configurator to precode prior to delivery.

Incorrect assembly on the circuit board and incorrect plugging of connecting elements is no longer possible.

The advantage: no troubleshooting during manufacture and no operational errors by the user.

BLC 5.08/02/180BR BK BX

Weidmüller Interface GmbH & Co. KG
 Klingenbergstraße 26
 D-32758 Detmold
 Germany

www.weidmueller.com

Accessories

General ordering data

Type	BLZ/SL KO BK BX	Version
Order No.	1545710000	PCB plug-in connector, Accessories, Coding element, black, Number
GTIN (EAN)	4008190087142	of poles: 1
Qty.	50 ST	
Type	BLZ/SL KO OR BX	Version
Order No.	1573010000	PCB plug-in connector, Accessories, Coding element, orange, Number
GTIN (EAN)	4008190048396	of poles: 1
Qty.	100 ST	

Crimp contacts



General ordering data

Type	DFFC 0.22-0.35 SN 3000	Version
Order No.	1604230000	PCB plug-in connector, Crimp contact, Contact, tinned, Max. clamping
GTIN (EAN)	4008190117498	range : 0.35 mm ²
Qty.	3000 ST	
Type	DFFC 0.22-0.35 SN E	Version
Order No.	1604250000	PCB plug-in connector, Crimp contact, Contact, tinned, Max. clamping
GTIN (EAN)	4008190042905	range : 0.35 mm ²
Qty.	250 ST	
Type	DFFC 0.5-1.0 SN 3000	Version
Order No.	1480000000	PCB plug-in connector, Crimp contact, Contact, tinned, Max. clamping
GTIN (EAN)	4008190179175	range : 1 mm ²
Qty.	3000 ST	
Type	DFFC 0.5-1.0 SN E	Version
Order No.	1567060000	PCB plug-in connector, Crimp contact, Contact, tinned, Max. clamping
GTIN (EAN)	4008190166991	range : 1 mm ²
Qty.	250 ST	
Type	DFFC 1.5-2.5 SN 2500	Version
Order No.	1480100000	PCB plug-in connector, Crimp contact, Contact, tinned, Max. clamping
GTIN (EAN)	4008190100414	range : 2.5 mm ²
Qty.	2500 ST	
Type	DFFC 1.5-2.5 SN E	Version
Order No.	1567070000	PCB plug-in connector, Crimp contact, Contact, tinned, Max. clamping
GTIN (EAN)	4008190059071	range : 2.5 mm ²
Qty.	250 ST	

BLC 5.08/02/180BR BK BX

Weidmüller Interface GmbH & Co. KG
 Klingenbergstraße 26
 D-32758 Detmold
 Germany

www.weidmueller.com

Accessories

... for Weidmüller DFF and ZRV contacts



Crimping tools for for turned/stamped contact

- Ratchet guarantees precise crimping
- Release option in the event of incorrect operation
- With stop for exact positioning of the contacts.

General ordering data

Type	HTF DFF	Version	
Order No.	9014140000	Pressing tool, Crimping tool for contacts, 0.22mm ² , 2.5mm ² , B-Crimp	
GTIN (EAN)	4008190297305		
Qty.	1 ST		

Auxiliary tools



More intelligent. More efficient. Quicker.

Auxiliary tools simplify the process of connecting and configuring the connection components:

- Assembly blocks for socket connectors with IDC contacts (type BL-IDC) can be used in machines such as toggle lever presses. All conductors are connected at the same time.
- Unlocking and dismantling tools release the crimp contacts in crimped plug-in connectors (type BLC & BLAC)
- Operating levers open individual clamping points on plug-in tension clamp connectors

For better, more rapid working progress

The result: efficient, professional working progress.

General ordering data

Type	DFFC EW2	Version	
Order No.	1803790000	PCB plug-in connector	
GTIN (EAN)	4032248259311		
Qty.	10 ST		

BLC 5.08/02/180BR BK BX

Weidmüller Interface GmbH & Co. KG
 Klingenbergstraße 26
 D-32758 Detmold
 Germany

www.weidmueller.com

Counterpart**SLDF 5.08**

Male connector for through-panel mounting with optional locking function. Internal connection as flat-blade or solder connection. These male connectors provide space for labelling and can be coded.

General ordering data

Type	SLDF 5.08 L/F 2 SN BK BX	Version
Order No.	1635740000	PCB plug-in connector, male header, 5.08 mm, Number of poles: 2,
GTIN (EAN)	4008190264161	180°, Flat-blade connection, Solder connection, Box
Qty.	60 ST	
Type	SLDF 5.08 L/F 2 SN OR BX	Version
Order No.	1599130000	PCB plug-in connector, male header, 5.08 mm, Number of poles: 2,
GTIN (EAN)	4008190175931	180°, Flat-blade connection, Solder connection, Box
Qty.	60 ST	

SL 5.08/135

Male connectors with 135° outlet direction. The solder pin length is optimised for wave flow soldering. The pin headers provide space for labelling and can be coded.

General ordering data

Type	SL 5.08/02/135 3.2SN OR...	Version
Order No.	1603060000	PCB plug-in connector, male header, open side, THT solder
GTIN (EAN)	4008190095512	connection, 5.08 mm, Number of poles: 2, 135°, Solder pin length (l):
Qty.	100 ST	3.2 mm, tinned, orange, Box

SL 5.08/135B

Male connectors with 135° outlet direction. The solder pin length is optimised for wave flow soldering. The pin headers provide space for labelling and can be coded.

BLC 5.08/02/180BR BK BX

Weidmüller Interface GmbH & Co. KG
 Klingenbergstraße 26
 D-32758 Detmold
 Germany

www.weidmueller.com

Counterpart

General ordering data

Type	SL 5.08/02/135B 3.2SN O...	Version
Order No.	1605530000	PCB plug-in connector, male header, Dovetails for fixing blocks, THT
GTIN (EAN)	4008190104290	solder connection, 5.08 mm, Number of poles: 2, 135°, Solder pin
Qty.	100 ST	length (l): 3.2 mm, tinned, orange, Box

SL 5.08/180



Male connectors with straight outlet direction. The solder pin length is optimised for wave flow soldering. The pin headers provide space for labelling and can be coded.

General ordering data

Type	SL 5.08/02/180 3.2SN OR...	Version
Order No.	1517260000	PCB plug-in connector, male header, open side, THT solder
GTIN (EAN)	4008190034795	connection, 5.08 mm, Number of poles: 2, 180°, Solder pin length (l):
Qty.	100 ST	3.2 mm, tinned, orange, Box

SL 5.08/180B



Male connectors with straight outlet direction. The solder pin length is optimised for wave flow soldering. The pin headers provide space for labelling and can be coded.

General ordering data

Type	SL 5.08/02/180B 3.2SN O...	Version
Order No.	1519560000	PCB plug-in connector, male header, Dovetails for fixing blocks, THT
GTIN (EAN)	4008190083892	solder connection, 5.08 mm, Number of poles: 2, 180°, Solder pin
Qty.	100 ST	length (l): 3.2 mm, tinned, orange, Box

BLC 5.08/02/180BR BK BX

Weidmüller Interface GmbH & Co. KG
Klingenbergstraße 26
D-32758 Detmold
Germany

www.weidmueller.com

Counterpart

SL 5.08/90



Male connectors with 90° outlet direction. The solder pin length is optimised for wave flow soldering. The pin headers provide space for labelling and can be coded.

General ordering data

Type	SL 5.08/02/90 3.2SN OR ...	Version
Order No.	1508060000	PCB plug-in connector, male header, open side, THT solder
GTIN (EAN)	4008190189006	connection, 5.08 mm, Number of poles: 2, 90°, Solder pin length (l):
Qty.	100 ST	3.2 mm, tinned, orange, Box

SL 5.08/90B



Male connectors with 90° outlet direction. The solder pin length is optimised for wave flow soldering. The pin headers provide space for labelling and can be coded.

General ordering data

Type	SL 5.08/02/90B 3.2SN BK...	Version
Order No.	1510310000	PCB plug-in connector, male header, Dovetails for fixing blocks, THT
GTIN (EAN)	4008190477684	solder connection, 5.08 mm, Number of poles: 2, 90°, Solder pin
Qty.	100 ST	length (l): 3.2 mm, tinned, black, Box
Type	SL 5.08/02/90B 3.2SN OR...	Version
Order No.	1510360000	PCB plug-in connector, male header, Dovetails for fixing blocks, THT
GTIN (EAN)	4008190180188	solder connection, 5.08 mm, Number of poles: 2, 90°, Solder pin
Qty.	100 ST	length (l): 3.2 mm, tinned, orange, Box

SL 5.08HC/180



Pin headers in glass-fibre-reinforced plastic with straight wire outlet; optimised for wave soldering. The flange variant (F) can be screwed onto the respective counter piece or the circuit board. There is no need for an extra screw to connect the circuit board when the solder flange (LF) version is used. This also protects the solder points from mechanical strain. All pin headers can be manually coded or ordered pre-coded. HC = High Current.

BLC 5.08/02/180BR BK BX

Weidmüller Interface GmbH & Co. KG
Klingenbergstraße 26
D-32758 Detmold
Germany

www.weidmueller.com

Counterpart

General ordering data

Type	SL 5.08HC/02/180 3.2SN ...	Version
Order No.	1148080000	PCB plug-in connector, male header, open side, THT solder
GTIN (EAN)	4032248934386	connection, 5.08 mm, Number of poles: 2, 180°, Solder pin length (l):
Qty.	100 ST	3.2 mm, tinned, black, Box
Type	SL 5.08HC/02/180 3.2SN ...	Version
Order No.	1146320000	PCB plug-in connector, male header, open side, THT solder
GTIN (EAN)	4032248108916	connection, 5.08 mm, Number of poles: 2, 180°, Solder pin length (l):
Qty.	100 ST	3.2 mm, tinned, orange, Box

SL 5.08HC/180B



Pin headers in glass-fibre-reinforced plastic with straight wire outlet; optimised for wave soldering. The flange variant (F) can be screwed onto the respective counter piece or the circuit board. There is no need for an extra screw to connect the circuit board when the solder flange (LF) version is used. This also protects the solder points from mechanical strain. All pin headers can be manually coded or ordered pre-coded. HC = High Current.

General ordering data

Type	SL 5.08HC/02/180B 3.2SN...	Version
Order No.	1149400000	PCB plug-in connector, male header, Dovetails for fixing blocks, THT
GTIN (EAN)	4032248934669	solder connection, 5.08 mm, Number of poles: 2, 180°, Solder pin
Qty.	100 ST	length (l): 3.2 mm, tinned, black, Box
Type	SL 5.08HC/02/180B 3.2SN...	Version
Order No.	1147300000	PCB plug-in connector, male header, Dovetails for fixing blocks, THT
GTIN (EAN)	4032248933839	solder connection, 5.08 mm, Number of poles: 2, 180°, Solder pin
Qty.	100 ST	length (l): 3.2 mm, tinned, orange, Box

SL 5.08HC/180G



Pin headers in glass-fibre-reinforced plastic with straight wire outlet; optimised for wave soldering. The flange variant (F) can be screwed onto the respective counter piece or the circuit board. There is no need for an extra screw to connect the circuit board when the solder flange (LF) version is used. This also protects the solder points from mechanical strain. All pin headers can be manually coded or ordered pre-coded. HC = High Current.

General ordering data

Type	SL 5.08HC/02/180G 3.2SN...	Version
Order No.	1148630000	PCB plug-in connector, male header, closed side, THT solder
GTIN (EAN)	4032248934409	connection, 5.08 mm, Number of poles: 2, 180°, Solder pin length (l):
Qty.	100 ST	3.2 mm, tinned, black, Box
Type	SL 5.08HC/02/180G 3.2SN...	Version
Order No.	1146730000	PCB plug-in connector, male header, closed side, THT solder
GTIN (EAN)	4032248108688	connection, 5.08 mm, Number of poles: 2, 180°, Solder pin length (l):
Qty.	100 ST	3.2 mm, tinned, orange, Box

BLC 5.08/02/180BR BK BX

Weidmüller Interface GmbH & Co. KG
Klingenbergstraße 26
D-32758 Detmold
Germany

Counterpart

www.weidmueller.com

SL 5.08HC/90

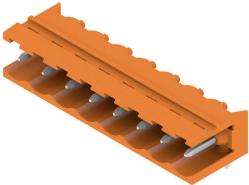

Pin headers made from glass-fibre-reinforced plastic with 90° wire outlet; optimised for wave soldering. The flange variant (F) can be screwed onto the respective counter piece or the circuit board. There is no need for an extra screw to connect the circuit board when the solder flange (LF) version is used. This also protects the solder points from mechanical strain. All pin headers can be manually coded or ordered pre-coded. HC = High Current.

General ordering data

Type	SL 5.08HC/02/90 3.2SN B...	Version
Order No.	1155030000	PCB plug-in connector, male header, open side, THT solder
GTIN (EAN)	4050118050813	connection, 5.08 mm, Number of poles: 2, 90°, Solder pin length (l):
Qty.	100 ST	3.2 mm, tinned, black, Box
Type	SL 5.08HC/02/90 3.2SN O...	Version
Order No.	1146720000	PCB plug-in connector, male header, open side, THT solder
GTIN (EAN)	4050118051506	connection, 5.08 mm, Number of poles: 2, 90°, Solder pin length (l):
Qty.	100 ST	3.2 mm, tinned, orange, Box

SL 5.08HC/90B



Pin headers made from glass-fibre-reinforced plastic with 90° wire outlet; optimised for wave soldering. The flange variant (F) can be screwed onto the respective counter piece or the circuit board. There is no need for an extra screw to connect the circuit board when the solder flange (LF) version is used. This also protects the solder points from mechanical strain. All pin headers can be manually coded or ordered pre-coded. HC = High Current.

General ordering data

Type	SL 5.08HC/02/90B 3.2SN ...	Version
Order No.	1155580000	PCB plug-in connector, male header, Dovetails for fixing blocks, THT
GTIN (EAN)	4050118050356	solder connection, 5.08 mm, Number of poles: 2, 90°, Solder pin
Qty.	100 ST	length (l): 3.2 mm, tinned, black, Box
Type	SL 5.08HC/02/90B 3.2SN ...	Version
Order No.	1148030000	PCB plug-in connector, male header, Dovetails for fixing blocks, THT
GTIN (EAN)	4050118051049	solder connection, 5.08 mm, Number of poles: 2, 90°, Solder pin
Qty.	100 ST	length (l): 3.2 mm, tinned, orange, Box

BLC 5.08/02/180BR BK BX

Weidmüller Interface GmbH & Co. KG
Klingenbergstraße 26
D-32758 Detmold
Germany

Counterpart

www.weidmueller.com

SL 5.08HC/90G



Pin headers made from glass-fibre-reinforced plastic with 90° wire outlet; optimised for wave soldering. The flange variant (F) can be screwed onto the respective counter piece or the circuit board. There is no need for an extra screw to connect the circuit board when the solder flange (LF) version is used. This also protects the solder points from mechanical strain. All pin headers can be manually coded or ordered pre-coded. HC = High Current.

General ordering data

Type	SL 5.08HC/02/90G 3.2SN ...	Version
Order No.	1155320000	PCB plug-in connector, male header, closed side, THT solder
GTIN (EAN)	4050118050585	connection, 5.08 mm, Number of poles: 2, 90°, Solder pin length (l):
Qty.	100 ST	3.2 mm, tinned, black, Box
Type	SL 5.08HC/02/90G 3.2SN ...	Version
Order No.	1147280000	PCB plug-in connector, male header, closed side, THT solder
GTIN (EAN)	4050118051278	connection, 5.08 mm, Number of poles: 2, 90°, Solder pin length (l):
Qty.	100 ST	3.2 mm, tinned, orange, Box

SLDV 5.08/180



Pin headers with solder pin length optimised for wave flow soldering. The male connectors provide space for labelling and can be coded. HC = High Current.

General ordering data

Type	SLD 5.08V/04/180 3.2SN ...	Version
Order No.	1725650000	PCB plug-in connector, male header, open side, THT solder
GTIN (EAN)	4032248061945	connection, 5.08 mm, Number of poles: 4, 180°, Solder pin length (l):
Qty.	50 ST	3.2 mm, tinned, orange, Box

SLDV 5.08/180B



Pin headers with solder pin length optimised for wave flow soldering. The male connectors provide space for labelling and can be coded. HC = High Current.

BLC 5.08/02/180BR BK BX

Weidmüller Interface GmbH & Co. KG
 Klingenbergstraße 26
 D-32758 Detmold
 Germany

www.weidmuller.com

Counterpart

General ordering data

Type	SLD 5.08V/04/180B 3.2SN...	Version
Order No.	1726740000	PCB plug-in connector, male header, Dovetails for fixing blocks, THT
GTIN (EAN)	4032248062621	solder connection, 5.08 mm, Number of poles: 4, 180°, Solder pin
Qty.	50 ST	length (l): 3.2 mm, tinned, orange, Box

SLDV 5.08/90



Pin headers with solder pin length optimised for wave flow soldering. The male connectors provide space for labelling and can be coded. HC = High Current.

General ordering data

Type	SLD 5.08V/04/90 3.2 SN ...	Version
Order No.	1725170000	PCB plug-in connector, male header, open side, THT solder
GTIN (EAN)	4032248060573	connection, 5.08 mm, Number of poles: 4, 90°, Solder pin length (l):
Qty.	50 ST	3.2 mm, tinned, orange, Box

SLDV 5.08/90B



Pin headers with solder pin length optimised for wave flow soldering. The male connectors provide space for labelling and can be coded. HC = High Current.

General ordering data

Type	SLD 5.08V/04/90B 3.2 SN...	Version
Order No.	1726280000	PCB plug-in connector, male header, Dovetails for fixing blocks, THT
GTIN (EAN)	4032248061259	solder connection, 5.08 mm, Number of poles: 4, 90°, Solder pin
Qty.	50 ST	length (l): 3.2 mm, tinned, orange, Box

BLC 5.08/02/180BR BK BX

Weidmüller Interface GmbH & Co. KG
 Klingenbergstraße 26
 D-32758 Detmold
 Germany

Counterpart

www.weidmueller.com

SL-SMT 5.08/180 Box

High-temperature-resistant, straight, open pin header. Packed in box or tape. On tape and with 1.5 mm solder pin, optimised for automatic assembly. 3.2 mm solder pin suitable for reflow and wave soldering. The pin headers provide space for labelling and can be coded. HC = High Current.

General ordering data

Type	SL-SMT 5.08HC/02/180 1...	Version
Order No.	1775522001	PCB plug-in connector, male header, open side, THT/THR solder connection, 5.08 mm, Number of poles: 2, 180°, Solder pin length (l):
GTIN (EAN)	4032248157549	
Qty.	100 ST	1.5 mm, tinned, black, Box
Type	SL-SMT 5.08HC/02/180 3...	Version
Order No.	1837980000	PCB plug-in connector, male header, open side, THT/THR solder connection, 5.08 mm, Number of poles: 2, 180°, Solder pin length (l):
GTIN (EAN)	4032248348046	
Qty.	100 ST	3.2 mm, tinned, black, Box

SL-SMT 5.08/180 Tape

High-temperature-resistant, straight, open pin header. Packed in box or tape. On tape and with 1.5 mm solder pin, optimised for automatic assembly. 3.2 mm solder pin suitable for reflow and wave soldering. The pin headers provide space for labelling and can be coded. HC = High Current.

General ordering data

Type	SL-SMT 5.08HC/02/180 1...	Version
Order No.	1821100000	PCB plug-in connector, male header, open side, THT/THR solder connection, 5.08 mm, Number of poles: 2, 180°, Solder pin length (l):
GTIN (EAN)	4032248319749	
Qty.	250 ST	1.5 mm, tinned, black, Tape

SL-SMT 5.08/180G Box

High-temperature-resistant pin header, packed in box or tape. On tape, with 1.5 mm solder pin, optimised for automatic assembly. 3.2 mm solder pin suitable for reflow and wave soldering. The pin headers provide space for labelling and can be coded. HC = High Current.

BLC 5.08/02/180BR BK BX

Weidmüller Interface GmbH & Co. KG
Klingenbergstraße 26
D-32758 Detmold
Germany

www.weidmueller.com

Counterpart

General ordering data

Type	SL-SMT 5.08HC/02/180G 1...	Version
Order No.	1775922001	PCB plug-in connector, male header, closed side, THT/THR solder connection, 5.08 mm, Number of poles: 2, 180°, Solder pin length (l):
GTIN (EAN)	4032248158911	1.5 mm, tinned, black, Box
Qty.	100 ST	
Type	SL-SMT 5.08HC/02/180G 3...	Version
Order No.	1838210000	PCB plug-in connector, male header, closed side, THT/THR solder connection, 5.08 mm, Number of poles: 2, 180°, Solder pin length (l):
GTIN (EAN)	4032248348275	3.2 mm, tinned, black, Box
Qty.	100 ST	

SL-SMT 5.08/180G Tape

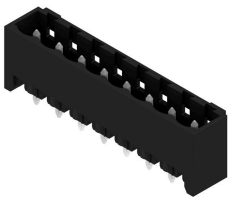

High-temperature-resistant pin header, packed in box or tape. On tape, with 1.5 mm solder pin, optimised for automatic assembly. 3.2 mm solder pin suitable for reflow and wave soldering. The pin headers provide space for labelling and can be coded. HC = High Current.

General ordering data

Type	SL-SMT 5.08HC/02/180G 1...	Version
Order No.	1820170000	PCB plug-in connector, male header, closed side, THT/THR solder connection, 5.08 mm, Number of poles: 2, 180°, Solder pin length (l):
GTIN (EAN)	4032248315680	1.5 mm, tinned, black, Tape
Qty.	250 ST	

SL-SMT 5.08/270GH Box



High-temperature-resistant, straight, open pin header. Packed in box or tape. On tape and with 1.5 mm solder pin, optimised for automatic assembly. 3.2 mm solder pin suitable for reflow and wave soldering. The pin headers provide space for labelling and can be coded. HC = High Current.

General ordering data

Type	SL-SMT 5.08HC/02/270GH ...	Version
Order No.	1876340000	PCB plug-in connector, male header, closed side, THT/THR solder connection, 5.08 mm, Number of poles: 2, 270°, Solder pin length (l):
GTIN (EAN)	4032248466818	1.5 mm, tinned, black, Box
Qty.	100 ST	
Type	SL-SMT 5.08HC/02/270GH ...	Version
Order No.	1877370000	PCB plug-in connector, male header, closed side, THT/THR solder connection, 5.08 mm, Number of poles: 2, 270°, Solder pin length (l):
GTIN (EAN)	4032248468003	3.2 mm, tinned, black, Box
Qty.	100 ST	

BLC 5.08/02/180BR BK BX

Weidmüller Interface GmbH & Co. KG
Klingenbergstraße 26
D-32758 Detmold
Germany

Counterpart

www.weidmueller.com

SL-SMT 5.08/270GH Tape



High-temperature-resistant, straight, open pin header. Packed in box or tape. On tape and with 1.5 mm solder pin, optimised for automatic assembly. 3.2 mm solder pin suitable for reflow and wave soldering. The pin headers provide space for labelling and can be coded. HC = High Current.

General ordering data

Type	SL-SMT 5.08HC/02/270GH ...	Version
Order No.	1877560000	PCB plug-in connector, male header, closed side, THT/THR solder connection, 5.08 mm, Number of poles: 2, 270°, Solder pin length (l):
GTIN (EAN)	4032248468188	
Qty.	335 ST	1.5 mm, tinned, black, Tape
Type	SL-SMT 5.08HC/02/270GH ...	Version
Order No.	1877810000	PCB plug-in connector, male header, closed side, THT/THR solder connection, 5.08 mm, Number of poles: 2, 270°, Solder pin length (l):
GTIN (EAN)	4032248468461	
Qty.	335 ST	3.2 mm, tinned, black, Tape

SL-SMT 5.08/270GL Box



High-temperature-resistant, straight, open pin header. Packed in box or tape. On tape and with 1.5 mm solder pin, optimised for automatic assembly. 3.2 mm solder pin suitable for reflow and wave soldering. The pin headers provide space for labelling and can be coded. HC = High Current.

General ordering data

Type	SL-SMT 5.08HC/02/270GL ...	Version
Order No.	1877100000	PCB plug-in connector, male header, closed side, THT/THR solder connection, 5.08 mm, Number of poles: 2, 270°, Solder pin length (l):
GTIN (EAN)	4032248467570	
Qty.	100 ST	1.5 mm, tinned, black, Box
Type	SL-SMT 5.08HC/02/270GL ...	Version
Order No.	1877470000	PCB plug-in connector, male header, closed side, THT/THR solder connection, 5.08 mm, Number of poles: 2, 270°, Solder pin length (l):
GTIN (EAN)	4032248468096	
Qty.	100 ST	3.2 mm, tinned, black, Box

BLC 5.08/02/180BR BK BX

Weidmüller Interface GmbH & Co. KG
 Klingenbergstraße 26
 D-32758 Detmold
 Germany

Counterpart

www.weidmueller.com

SL-SMT 5.08/270GL Tape



High-temperature-resistant, straight, open pin header. Packed in box or tape. On tape and with 1.5 mm solder pin, optimised for automatic assembly. 3.2 mm solder pin suitable for reflow and wave soldering. The pin headers provide space for labelling and can be coded. HC = High Current.

General ordering data

Type	SL-SMT 5.08HC/02/270GL ...	Version
Order No.	1877740000	PCB plug-in connector, male header, closed side, THT/THR solder connection, 5.08 mm, Number of poles: 2, 270°, Solder pin length (l):
GTIN (EAN)	4032248467891	
Qty.	350 ST	1.5 mm, tinned, black, Tape

SL-SMT 5.08HC/90 Box



High-temperature-resistant, 90° angled, open male header. Packed in box or tape. On tape, with 1.5 mm solder pin, optimised for automatic assembly. 3.2 mm solder pin suitable for reflow and wave soldering. The pin headers provide space for labelling and can be coded. HC = High Current.

General ordering data

Type	SL-SMT 5.08HC/02/90 1.5...	Version
Order No.	1774762001	PCB plug-in connector, male header, open side, THT/THR solder connection, 5.08 mm, Number of poles: 2, 90°, Solder pin length (l):
GTIN (EAN)	4032248155699	
Qty.	100 ST	1.5 mm, tinned, black, Box
Type	SL-SMT 5.08HC/02/90 3.2...	Version
Order No.	1779950000	PCB plug-in connector, male header, open side, THT/THR solder connection, 5.08 mm, Number of poles: 2, 90°, Solder pin length (l):
GTIN (EAN)	4032248165278	
Qty.	100 ST	3.2 mm, tinned, black, Box

SL-SMT 5.08HC/90 Tape



High-temperature-resistant, 90° angled, open male header. Packed in box or tape. On tape, with 1.5 mm solder pin, optimised for automatic assembly. 3.2 mm solder pin suitable for reflow and wave soldering. The pin headers provide space for labelling and can be coded. HC = High Current.

BLC 5.08/02/180BR BK BX

Weidmüller Interface GmbH & Co. KG
 Klingenbergstraße 26
 D-32758 Detmold
 Germany

www.weidmueller.com

Counterpart**General ordering data**

Type	SL-SMT 5.08HC/02/90 1.5...	Version
Order No.	1821160000	PCB plug-in connector, male header, open side, THT/THR solder
GTIN (EAN)	4032248319800	connection, 5.08 mm, Number of poles: 2, 90°, Solder pin length (l):
Qty.	350 ST	1.5 mm, tinned, black, Tape

SL-SMT 5.08HC/90G Box

High-temperature-resistant pin header, packed in box or tape. On tape, with 1.5 mm solder pin, optimised for automatic assembly. 3.2 mm solder pin suitable for reflow and wave soldering. The pin headers provide space for labelling and can be coded. HC = High Current.

General ordering data

Type	SL-SMT 5.08HC/02/90G 1....	Version
Order No.	1775002001	PCB plug-in connector, male header, closed side, THT/THR solder
GTIN (EAN)	4032248156023	connection, 5.08 mm, Number of poles: 2, 90°, Solder pin length (l):
Qty.	100 ST	1.5 mm, tinned, black, Box
Type	SL-SMT 5.08HC/02/90G 3....	Version
Order No.	1780180000	PCB plug-in connector, male header, closed side, THT/THR solder
GTIN (EAN)	4032248165506	connection, 5.08 mm, Number of poles: 2, 90°, Solder pin length (l):
Qty.	100 ST	3.2 mm, tinned, black, Box

SL-SMT 5.08HC/90G Tape

High-temperature-resistant pin header, packed in box or tape. On tape, with 1.5 mm solder pin, optimised for automatic assembly. 3.2 mm solder pin suitable for reflow and wave soldering. The pin headers provide space for labelling and can be coded. HC = High Current.

General ordering data

Type	SL-SMT 5.08HC/02/90G 1....	Version
Order No.	1821140000	PCB plug-in connector, male header, closed side, THT/THR solder
GTIN (EAN)	4032248319787	connection, 5.08 mm, Number of poles: 2, 90°, Solder pin length (l):
Qty.	350 ST	1.5 mm, tinned, black, Tape

BLC 5.08/02/180BR BK BX

Weidmüller Interface GmbH & Co. KG
 Klingenbergstraße 26
 D-32758 Detmold
 Germany

Counterpart

www.weidmueller.com

SLF 5.08/180 SN



Male plug with PUSH IN wire connection and straight outlet direction, when used with BLF 5.08HC as wire-to-wire application for panel feed-through The male plugs provide space for labelling and can be coded.

General ordering data

Type	SLF 5.08/02/180 SN BK BX	Version
Order No.	1335560000	PCB plug-in connector, male plug, 5.08 mm, Number of poles: 2,
GTIN (EAN)	4050118138740	180°, PUSH IN with actuator, Clamping range, max. : 3.31 mm ² , Box
Qty.	180 ST	
Type	SLF 5.08/02/180 SN OR BX	Version
Order No.	1335330000	PCB plug-in connector, male plug, 5.08 mm, Number of poles: 2,
GTIN (EAN)	4050118138559	180°, PUSH IN with actuator, Clamping range, max. : 3.31 mm ² , Box
Qty.	180 ST	

SLF 5.08/180B SN

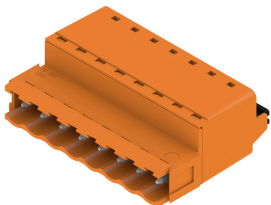

Male plug with PUSH IN wire connection and straight outlet direction, when used with BLF 5.08HC as wire-to-wire application for panel feed-through The male plugs provide space for labelling and can be coded.

General ordering data

Type	SLF 5.08/02/180B SN BK ...	Version
Order No.	1335770000	PCB plug-in connector, male plug, 5.08 mm, Number of poles: 2,
GTIN (EAN)	4050118140590	180°, PUSH IN with actuator, Clamping range, max. : 3.31 mm ² , Box
Qty.	150 ST	
Type	SLF 5.08/02/180B SN OR ...	Version
Order No.	1335440000	PCB plug-in connector, male plug, 5.08 mm, Number of poles: 2,
GTIN (EAN)	4050118138832	180°, PUSH IN with actuator, Clamping range, max. : 3.31 mm ² , Box
Qty.	150 ST	

BLC 5.08/02/180BR BK BX

Weidmüller Interface GmbH & Co. KG
 Klingenbergstraße 26
 D-32758 Detmold
 Germany

Counterpart

www.weidmueller.com

SLF 5.08/180DF SN



Male plug with PUSH IN wire connection and straight outlet direction, when used with BLF 5.08HC as wire-to-wire application for panel feed-through The male plugs provide space for labelling and can be coded.

General ordering data

Type	SLF 5.08/02/180DF SN OR...	Version
Order No.	1353580000	PCB plug-in connector, male plug, 5.08 mm, Number of poles: 2,
GTIN (EAN)	4050118156430	180°, PUSH IN with actuator, Clamping range, max. : 3.31 mm², Box
Qty.	54 ST	

SLT 5.08/180DF SN



Male plugs with screw TOP wire connection. The male plug provides space for labelling and can be coded.

General ordering data

Type	SLT 5.08/02/180DF SN OR...	Version
Order No.	1353350000	PCB plug-in connector, male plug, 5.08 mm, Number of poles: 2,
GTIN (EAN)	4050118156645	180°, TOP connection, Clamping range, max. : 2.5 mm², Box
Qty.	54 ST	

SLT 5.08B



Male plugs with screw TOP wire connection. The male plug provides space for labelling and can be coded.

General ordering data

Type	SLT 5.08/02/180B SN OR ...	Version
Order No.	1611710000	PCB plug-in connector, male plug, 5.08 mm, Number of poles: 2,
GTIN (EAN)	4008190192594	180°, TOP connection, Clamping range, max. : 2.5 mm², Box
Qty.	100 ST	

BLC 5.08/02/180BR BK BX

Weidmüller Interface GmbH & Co. KG
Klingenbergstraße 26
D-32758 Detmold
Germany

www.weidmueller.com

Counterpart

SLS 5.08/180 SN



Male plugs with clamping-yoke screw wire-connect system. The male plugs provide space for labelling and can be coded.

General ordering data

Type	SLS 5.08/02/180 SN OR BX	Version
Order No.	1627090000	PCB plug-in connector, male plug, 5.08 mm, Number of poles: 2,
GTIN (EAN)	4008190199609	180°, Clamping yoke connection, Clamping range, max. : 3.31 mm ² ,
Qty.	180 ST	Box

SLS 5.08/180B

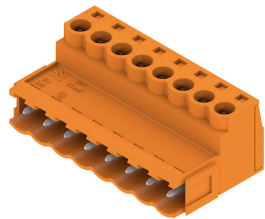

Male plugs with clamping-yoke screw wire-connect system. The male plugs provide space for labelling and can be coded.

General ordering data

Type	SLS 5.08/02/180B SN OR ...	Version
Order No.	1627240000	PCB plug-in connector, male plug, 5.08 mm, Number of poles: 2,
GTIN (EAN)	4008190199753	180°, Clamping yoke connection, Clamping range, max. : 3.31 mm ² ,
Qty.	150 ST	Box

SLS 5.08/180DF SN

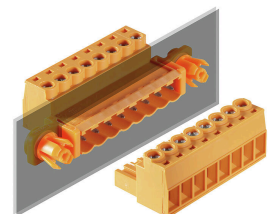

Male plugs with clamping-yoke screw wire-connect system. The male plugs provide space for labelling and can be coded.

General ordering data

Type	SLS 5.08/02/180DF SN OR...	Version
Order No.	1353470000	PCB plug-in connector, male plug, 5.08 mm, Number of poles: 2,
GTIN (EAN)	4050118156218	180°, Clamping yoke connection, Clamping range, max. : 3.31 mm ² ,
Qty.	54 ST	Box