

SLS 5.08/10/180DF SN OR BX

Weidmüller Interface GmbH & Co. KG
 Klingenbergstraße 26
 D-32758 Detmold
 Germany

www.weidmueller.com

Product image

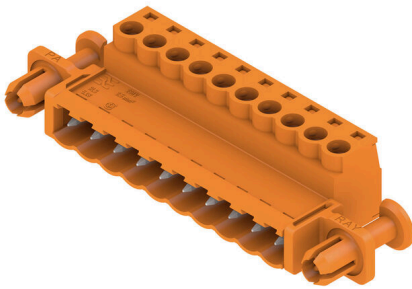

Male plugs with clamping-yoke screw wire-connect system. The male plugs provide space for labelling and can be coded.

General ordering data

Version	PCB plug-in connector, male plug, 5.08 mm, Number of poles: 10, 180°, Clamping yoke connection, Clamping range, max. : 3.31 mm², Box
Order No.	1353570000
Type	SLS 5.08/10/180DF SN OR BX
GTIN (EAN)	4050118156294
Qty.	24 items
Product data	IEC: 400 V / 21.5 A / 0.2 - 2.5 mm² UL: 300 V / 14 A / AWG 26 - AWG 12
Packaging	Box

SLS 5.08/10/180DF SN OR BX

Weidmüller Interface GmbH & Co. KG
 Klingenbergstraße 26
 D-32758 Detmold
 Germany

www.weidmueller.com

Technical data

Approvals

Approvals



ROHS	Conform
UL File Number Search	UL Website
Certificate No. (UR)	E60693

Dimensions and weights

Depth	22.2 mm	Depth (inches)	0.874 inch
Height	15.3 mm	Height (inches)	0.6024 inch
Width	80.1 mm	Width (inches)	3.1535 inch
Net weight	17.27 g		

Environmental Product Compliance

RoHS Compliance Status	Compliant without exemption
REACH SVHC	No SVHC above 0.1 wt%

System Parameters

Product family	OMNIMATE Signal - series BL/SL 5.08		
Type of connection	Field connection		
Wire connection method	Clamping yoke connection		
Pitch in mm (P)	5.08 mm		
Pitch in inches (P)	0.200 "		
Conductor outlet direction	180°		
Number of poles	10		
L1 in mm	45.72 mm		
L1 in inches	1.800 "		
Number of rows	1		
Pin series quantity	1		
Touch-safe protection acc. to DIN VDE 57 106	finger-safe plugged/ back-of-hand-safe unplugged		
Touch-safe protection acc. to DIN VDE 0470	IP20 plugged/ IP10 unplugged		
Protection degree	IP20, when fully mounted		
Volume resistance	4.50 mΩ		
Can be coded	Yes		
Stripping length	7 mm		
Tightening torque, min.	0.4 Nm		
Tightening torque, max.	0.5 Nm		
Clamping screw	M 2.5		
Screwdriver blade	0.6 x 3.5		
Screwdriver blade standard	DIN 5264-A		
Plugging cycles	25		
Plugging force/pole, max.	4 N		
Pulling force/pole, max.	3 N		
Tightening torque	Torque type	Wire connection	
	Usage information	Tightening torque	min. 0.4 Nm max. 0.5 Nm

SLS 5.08/10/180DF SN OR BX

Weidmüller Interface GmbH & Co. KG
 Klingenbergstraße 26
 D-32758 Detmold
 Germany

www.weidmueller.com

Technical data

Material data

Insulating material	PBT	Colour	orange
Colour chart (similar)	RAL 2000	Insulating material group	Illa
Comparative Tracking Index (CTI)	≥ 200	Moisture Level (MSL)	
UL 94 flammability rating	V-0	Contact material	Cu-alloy
Contact surface	tinned	Layer structure of plug contact	4...8 µm Sn hot-dip tinned
Storage temperature, min.	-40 °C	Storage temperature, max.	70 °C
Operating temperature, min.	-50 °C	Operating temperature, max.	100 °C
Temperature range, installation, min.	-25 °C	Temperature range, installation, max.	100 °C

Conductors suitable for connection

Clamping range, min.	0.13 mm ²
Clamping range, max.	3.31 mm ²
Wire connection cross section AWG, min.	AWG 26
Wire connection cross section AWG, max.	AWG 12
Solid, min. H05(07) V-U	0.2 mm ²
Solid, max. H05(07) V-U	2.5 mm ²
Stranded, min. H07V-R	0.2 mm ²
Stranded, max. H07V-R	2.5 mm ²
Flexible, min. H05(07) V-K	0.2 mm ²
Flexible, max. H05(07) V-K	2.5 mm ²
w. plastic collar ferrule, DIN 46228 pt 4, min.	0.2 mm ²
w. plastic collar ferrule, DIN 46228 pt 4, max.	2.5 mm ²
w. wire end ferrule, DIN 46228 pt 1, min.	0.2 mm ²
w. wire end ferrule, DIN 46228 pt 1, max.	2.5 mm ²
Plug gauge in accordance with EN 60999 a x b; ø	2.8 mm x 2.0 mm; 2.4 mm

Clampable conductor	Cross-section for conductor connection	Type	fine-wired
		nominal	0.5 mm ²
wire end ferrule	wire end ferrule	Stripping length	nominal 6 mm
		Recommended wire-end ferrule	H0.5/6
Cross-section for conductor connection	wire end ferrule	Type	fine-wired
		nominal	1 mm ²
wire end ferrule	wire end ferrule	Stripping length	nominal 6 mm
		Recommended wire-end ferrule	H1.0/6
Cross-section for conductor connection	wire end ferrule	Type	fine-wired
		nominal	1.5 mm ²
wire end ferrule	wire end ferrule	Stripping length	nominal 7 mm
		Recommended wire-end ferrule	H1.5/7
Cross-section for conductor connection	wire end ferrule	Type	fine-wired
		nominal	2.5 mm ²
wire end ferrule	wire end ferrule	Stripping length	nominal 7 mm
		Recommended wire-end ferrule	H2.5/7
Cross-section for conductor connection	wire end ferrule	Type	fine-wired
		nominal	0.75 mm ²
wire end ferrule	wire end ferrule	Stripping length	nominal 6 mm

SLS 5.08/10/180DF SN OR BX

Weidmüller Interface GmbH & Co. KG
 Klingenbergstraße 26
 D-32758 Detmold
 Germany

www.weidmueller.com

Technical data

Recommended wire-end ferrule [H0.75/6](#)

Reference text The outside diameter of the plastic collar should not be larger than the pitch (P), Length of ferrules is to be chosen depending on the product and the rated voltage.

Rated data acc. to IEC

tested acc. to standard	IEC 60664-1, IEC 61984	Rated current, min. number of poles (Tu=20°C)	21.5 A
Rated current, max. number of poles (Tu=20°C)	16 A	Rated current, min. number of poles (Tu=40°C)	18 A
Rated current, max. number of poles (Tu=40°C)	14 A	Rated voltage for surge voltage class / pollution degree II/2	400 V
Rated voltage for surge voltage class / pollution degree III/2	320 V	Rated voltage for surge voltage class / pollution degree III/3	250 V
Rated impulse voltage for surge voltage class/ pollution degree II/2	4 kV	Rated impulse voltage for surge voltage class/ pollution degree III/2	4 kV
Rated impulse voltage for surge voltage class/ contamination degree III/3	4 kV	Short-time withstand current resistance	3 x 1s with 120 A

Rated data acc. to CSA

Rated voltage (Use group B / CSA)	300 V	Rated voltage (Use group D / CSA)	300 V
Rated current (Use group B / CSA)	15 A	Rated current (Use group D / CSA)	10 A
Wire cross-section, AWG, min.	AWG 26	Wire cross-section, AWG, max.	AWG 12

Rated data acc. to UL 1059

Institute (UR)	UR	Certificate No. (UR)	E60693
Rated voltage (Use group B / UL 1059)	300 V	Rated voltage (Use group D / UL 1059)	300 V
Rated current (Use group B / UL 1059)	14 A	Rated current (Use group D / UL 1059)	10 A
Wire cross-section, AWG, min.	AWG 26	Wire cross-section, AWG, max.	AWG 12
Reference to approval values	Specifications are maximum values, details - see approval certificate.		

Packing

Packaging	Box	VPE length	350.00 mm
VPE width	139.00 mm	VPE height	32.00 mm

Type tests

Test: Durability of markings	Standard	VDE 0627 Tab. 7 item 3/6.86	
	Test	durability	
	Evaluation	passed	
Test: Clampable cross section	Standard	VDE 0609 part 1 06.83, EN 60947-1 03.91	
	Conductor type	Type of conductor and conductor cross-section	H05V-U0.5
		Type of conductor and conductor cross-section	H05V-K0.5
		Type of conductor and conductor cross-section	H05V-U2.5
		Type of conductor and conductor cross-section	H05V-K2.5

SLS 5.08/10/180DF SN OR BX

Weidmüller Interface GmbH & Co. KG
 Klingenbergstraße 26
 D-32758 Detmold
 Germany

www.weidmueller.com

Technical data

		Type of conductor and conductor cross-section	AWG 28
		Type of conductor and conductor cross-section	AWG 14
	Evaluation	passed	
Test for damage to and accidental loosening of conductors	Standard	EN 60947-1/1991 section 8.2.4.3	
	Requirement	0.3 kg	
	Conductor type	Type of conductor and conductor cross-section	H05V-U0.5
		Type of conductor and conductor cross-section	H05V-K0.5
	Evaluation	passed	
Requirement	0.7 kg		
Pull-out test	Conductor type	Type of conductor and conductor cross-section	H07V-U2.5
		Type of conductor and conductor cross-section	H07V-K2.5
	Evaluation	passed	
	Standard	EN 60947-1/1991 section 8.2.4.4	
	Requirement	≥5 N	
Conductor type	Type of conductor and conductor cross-section	AWG 28/1	
	Type of conductor and conductor cross-section	AWG 28/7	
	Evaluation	passed	
Requirement	≥50 N		
Conductor type	Type of conductor and conductor cross-section	H07V-U2.5	
	Type of conductor and conductor cross-section	H07V-K2.5	
	Type of conductor and conductor cross-section	AWG 14/19	
Evaluation	passed		

Important note

IPC conformity Conformity: The products are developed, manufactured and delivered according international recognized standards and norms and comply with the assured properties in the data sheet resp. fulfill decorative properties in accordance with IPC-A-610 "Class 2". Further claims on the products can be evaluated on request.

- Notes
- Additional variants on request
 - Rated current related to rated cross-section & min. No. of poles.
 - Wire end ferrule without plastic collar to DIN 46228/1
 - Wire end ferrule with plastic collar to DIN 46228/4
 - P on drawing = pitch
 - Rated data refer only to the component itself. Clearance and creepage distances to other components are to be designed in accordance with the relevant application standards.
 - In accordance with IEC 61984, OMNIMATE-connectors are connectors without breaking capacity (COC). During designated use, connectors are not allowed to be engaged or disengaged when live or under load
 - Long term storage of the product with average temperature of 50 °C and maximum humidity 70%, 36 months

SLS 5.08/10/180DF SN OR BX

Weidmüller Interface GmbH & Co. KG
Klingenbergstraße 26
D-32758 Detmold
Germany

www.weidmueller.com

Technical data

Classifications

ETIM 8.0	EC002638	ETIM 9.0	EC002638
ETIM 10.0	EC002638	ECLASS 14.0	27-46-02-02
ECLASS 15.0	27-46-02-02		

SLS 5.08/10/180DF SN OR BX

Weidmüller Interface GmbH & Co. KG
 Klingenbergstraße 26
 D-32758 Detmold
 Germany

www.weidmueller.com

Drawings

Product image

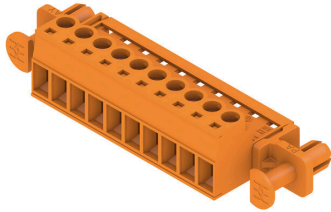

Dimensional drawing

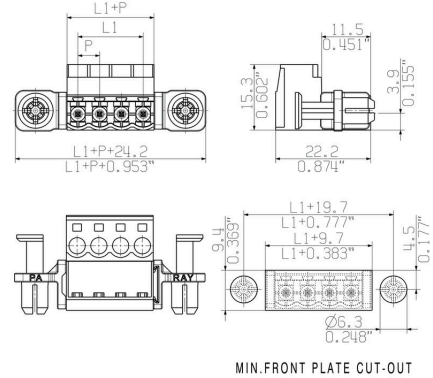

Graph



Graph



Graph



Product benefits



Lower assembly costs Secure in a matter of seconds

Product benefits



Flexible application options For 3 connection systems