

CSI P 2CO

Weidmüller Interface GmbH & Co. KG
 Klingenbergstraße 26
 D-32758 Detmold
 Germany

www.weidmueller.com

Technical data

Approvals

Approvals



ROHS Conform

UL File Number Search [UL Website](#)

Certificate No. (cURus) E223759

Dimensions and weights

Depth	45.9 mm	Depth (inches)	1.8071 inch
Height	97 mm	Height (inches)	3.8189 inch
Width	15.9 mm	Width (inches)	0.626 inch
Net weight	43 g		

Temperatures

Storage temperature	Ambient temperature	-40 °C...70 °C
Operating temperature	Humidity	40 °C / 93 % rel. humidity, no condensation

Environmental Product Compliance

RoHS Compliance Status	Compliant without exemption
REACH SVHC	No SVHC above 0.1 wt%

Rated data UL

Certificate No. (cURus) E223759

Control side

Status indicator No

Load side

Rated switching voltage	250 V AC	Continuous current	8 A @ 2CO; 12 A @ 1CO without bridged output wire connections; 16 A @ 1CO with bridged output wire connections
Max. switching voltage, AC	300 V	Contact type	2 CO contact

General data

Operating altitude	≤ 2000 m, above sea level		
Mounting rail	TS 35		
Colour	black		
UL 94 flammability rating	V-0		
UL94 flammability rating component	Component	Socket	
	UL94 flammability rating	V-0	

CSI P 2CO

Weidmüller Interface GmbH & Co. KG
 Klingenbergstraße 26
 D-32758 Detmold
 Germany

www.weidmueller.com

Technical data

Insulation coordination

Rated voltage	300 V	Pollution severity	2
Surge voltage category	II	Insulating material group	IIIa
Dielectric strength for control side - load side	5 kVeff / 1min	Dielectric strength of neighbouring contacts	3 KVeFF / 1 Min.
Dielectric strength to mounting rail	4 kVeff / 1 Min.	Impulse withstand voltage	4 kV
Protection degree	IP20		

Further details of approvals / standards

Certificate No. (CSA)	607178-80219312	Certificate No. (cURus)	E223759
-----------------------	-----------------	-------------------------	---------

Connection data

Wire connection method	PUSH IN	Stripping length, rated connection	8 mm
Clamping range, rated connection	1.5 mm ²	Clamping range, min.	0.5 mm ²
Clamping range, max.	1.5 mm ²	Wire cross-section, solid, min.	0.5 mm ²
Wire cross-section, solid, max.	1.5 mm ²	Wire cross-section, solid, min. (AWG)	AWG 20
Wire cross-section, solid, max. (AWG)	AWG 16	Wire connection cross section, finely stranded, max.	1.5 mm ²
Wire cross-section, finely stranded, min. (AWG)	AWG 24	Wire cross-section, finely stranded, max. (AWG)	AWG 16
Wire connection cross-section, finely stranded with wire-end ferrules DIN 46228/4, max.	1 mm ²	Conductor cross-section, flexible, AEH (DIN 46228-1), max.	1.5 mm ²
Blade size	0.6 x 3.5 mm		

Classifications

ETIM 8.0	EC001456	ETIM 9.0	EC001456
ETIM 10.0	EC001456	ECLASS 14.0	27-37-16-03
ECLASS 15.0	27-37-16-03		

Wiring diagram

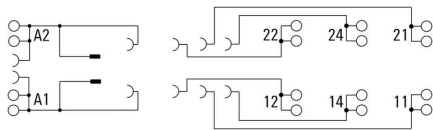

Dimensional drawing

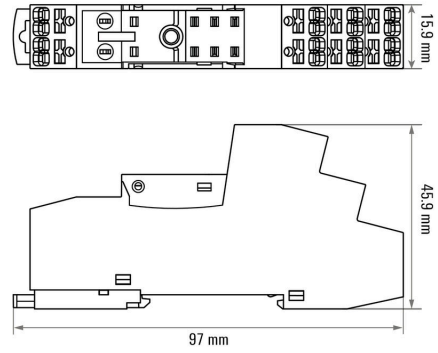

Dimensional drawing

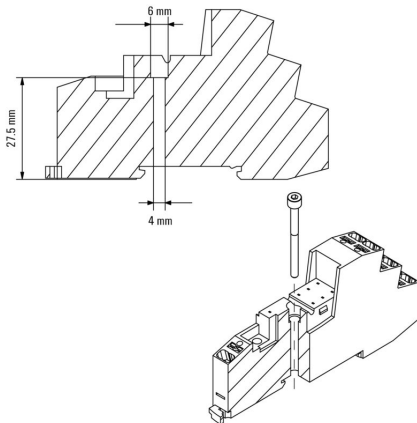

Miscellaneous

Insert flexible and solid cables

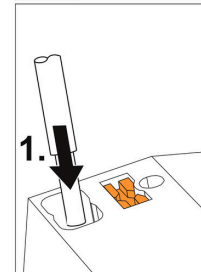

Solid wires can be inserted without opening the terminal.

Miscellaneous

Miscellaneous

Type code CUBESERIES socket versions

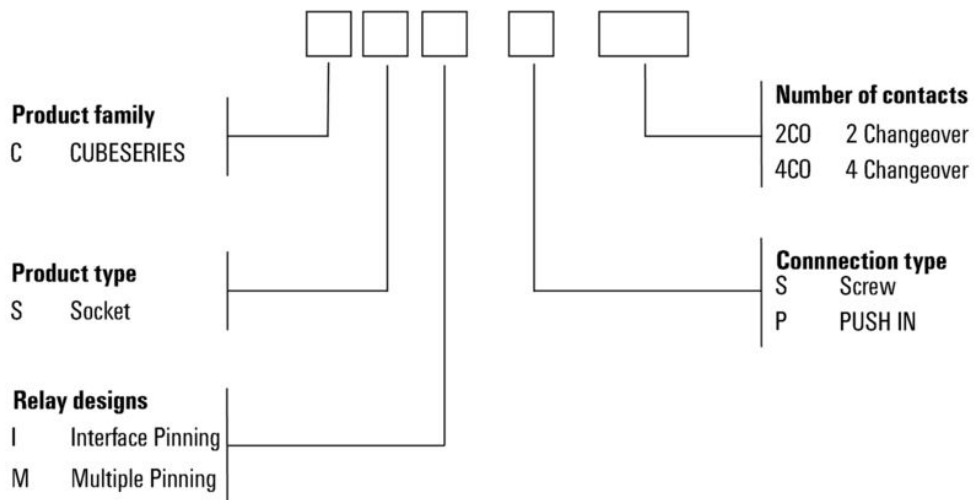

CSI P 2CO

Weidmüller Interface GmbH & Co. KG

Klingenbergstraße 26

D-32758 Detmold

Germany

www.weidmueller.com

Accessories

Cross-connections



Cross-connection for the sockets in the CUBESERIES CRI.

- Versions with red and blue coloured plastic for potential coding

Versions for PUSH IN sockets:

- 8-pin cross connection for A1 and A2 of the coil
- 2-pin jumper to connect to the neighbored sockets
- 2-pin jumper to connect the output channels within one socket

Version for screw sockets:

- 8-pin cross connection to connect to the neighbored sockets

General ordering data

Type	CXI CCP 2P BL	Version
Order No.	3052660000	CUBESERIES, Cross-connector
GTIN (EAN)	4099987022484	
Qty.	20 ST	
Type	CXI CCP 2P RD	Version
Order No.	3052650000	CUBESERIES, Cross-connector
GTIN (EAN)	4099987022477	
Qty.	20 ST	
Type	CXI CCP 8P BL	Version
Order No.	3052700000	CUBESERIES, Cross-connector
GTIN (EAN)	4099987022507	
Qty.	10 ST	
Type	CXI CCP 8P RD	Version
Order No.	3052690000	CUBESERIES, Cross-connector
GTIN (EAN)	4099987022491	
Qty.	10 ST	

Retaining clips



Retaining clips for CUBESERIES CRI relays.

Plastic retaining clip:

- With relay ejector function
- Marking slots for MultiFit markers
- Fits on relays with and without test button

Metal retaining clip:

- For a strong hold of the relay in the socket
- Individual versions for relays with and without test button

General ordering data

Type	CXI CLIP HM	Version
Order No.	3052640000	CUBESERIES, Retaining clip
GTIN (EAN)	4099987022460	
Qty.	10 ST	
Type	CXI CLIP LM	Version
Order No.	3052630000	CUBESERIES, Retaining clip
GTIN (EAN)	4099987022453	
Qty.	25 ST	

CSI P 2CO

Weidmüller Interface GmbH & Co. KG
 Klingenbergstraße 26
 D-32758 Detmold
 Germany

www.weidmueller.com

Accessories

Type	CXI CLIP P	Version
Order No.	3052710000	CUBESERIES, Retaining clip
GTIN (EAN)	4099987022514	
Qty.	10 ST	

Cross-connections



General ordering data

Type	CXX JMP 2P BL	Version
Order No.	3053260000	CUBESERIES, Cross-connector
GTIN (EAN)	4099987023085	
Qty.	30 ST	
Type	CXX JMP 2P RD	Version
Order No.	3053250000	CUBESERIES, Cross-connector
GTIN (EAN)	4099987023078	
Qty.	30 ST	

LED



General ordering data

Type	CXX L 61G	Version
Order No.	3053420000	CUBESERIES, LED module, Rated control voltage: 6...24 V UC, Plug-in connection
GTIN (EAN)	4099987023207	
Qty.	20 ST	
Type	CXX L 61R	Version
Order No.	3053410000	CUBESERIES, LED module, Rated control voltage: 6...24 V UC, Plug-in connection
GTIN (EAN)	4099987023191	
Qty.	20 ST	
Type	CXX L 62G	Version
Order No.	3053440000	CUBESERIES, LED module, Rated control voltage: 24...60 V UC, Plug-in connection
GTIN (EAN)	4099987023221	
Qty.	20 ST	

CSI P 2CO

Weidmüller Interface GmbH & Co. KG
 Klingenbergstraße 26
 D-32758 Detmold
 Germany

www.weidmueller.com

Accessories

Type	CXX L 62R	Version
Order No.	3053430000	CUBESERIES, LED module, Rated control voltage: 24...60 V UC, Plug-
GTIN (EAN)	4099987023214	in connection
Qty.	20 ST	
Type	CXX L 63G	Version
Order No.	3053460000	CUBESERIES, LED module, Rated control voltage: 110...230 V UC,
GTIN (EAN)	4099987023245	Plug-in connection
Qty.	20 ST	
Type	CXX L 63R	Version
Order No.	3053450000	CUBESERIES, LED module, Rated control voltage: 110...230 V UC,
GTIN (EAN)	4099987023238	Plug-in connection
Qty.	20 ST	

LED and free-wheel diode



General ordering data

Type	CXX LD 41G	Version
Order No.	3053310000	CUBESERIES, LED module with freewheel diode, Rated control
GTIN (EAN)	4099987023115	voltage: 6...24 V DC, Plug-in connection
Qty.	20 ST	
Type	CXX LD 41R	Version
Order No.	3053290000	CUBESERIES, LED module with freewheel diode, Rated control
GTIN (EAN)	4099987023108	voltage: 6...24 V DC, Plug-in connection
Qty.	20 ST	

LED and free-wheeling diode



General ordering data

Type	CXX LD 42G	Version
Order No.	3053340000	CUBESERIES, LED module with freewheel diode, Rated control
GTIN (EAN)	4099987023139	voltage: 24...60 V DC, Plug-in connection
Qty.	20 ST	

CSI P 2CO

Weidmüller Interface GmbH & Co. KG
 Klingenbergstraße 26
 D-32758 Detmold
 Germany

www.weidmueller.com

Accessories

LED and free-wheel diode



General ordering data

Type	CXX LD 42R	Version	
Order No.	3053320000	CUBESERIES, LED module with freewheel diode, Rated control	
GTIN (EAN)	4099987023 122	voltage: 24...60 V DC, Plug-in connection	
Qty.	20 ST		

LED and free-wheeling diode



General ordering data

Type	CXX LD 43G	Version	
Order No.	3053360000	CUBESERIES, LED module with freewheel diode, Rated control	
GTIN (EAN)	4099987023 153	voltage: 110...230 V DC, Plug-in connection	
Qty.	20 ST		

LED and free-wheel diode



General ordering data

Type	CXX LD 43R	Version	
Order No.	3053350000	CUBESERIES, LED module with freewheel diode, Rated control	
GTIN (EAN)	4099987023 146	voltage: 110...230 V DC, Plug-in connection	
Qty.	20 ST		

CSI P 2CO

Weidmüller Interface GmbH & Co. KG
 Klingenbergstraße 26
 D-32758 Detmold
 Germany

Accessories

www.weidmueller.com

Protection modules



General ordering data

Type	CXX D 21N	Version
Order No.	3053270000	CUBESERIES, Free-wheeling diode, Rated control voltage: 6...230 V
GTIN (EAN)	4099987023092	DC, Plug-in connection
Qty.	20 ST	
Type	CXX RC 51	Version
Order No.	3053370000	CUBESERIES, RC element, Rated control voltage: 6...24 V UC, Plug-in connection
GTIN (EAN)	4099987023160	
Qty.	20 ST	
Type	CXX RC 52	Version
Order No.	3053390000	CUBESERIES, RC element, Rated control voltage: 24...60 V UC, Plug-in connection
GTIN (EAN)	4099987023177	
Qty.	20 ST	
Type	CXX RC 53	Version
Order No.	3053400000	CUBESERIES, RC element, Rated control voltage: 110...230 V AC, Plug-in connection
GTIN (EAN)	4099987023184	
Qty.	20 ST	
Type	CXX V 71	Version
Order No.	3053470000	CUBESERIES, Protective varistor, Rated control voltage: 6...24 V AC, Plug-in connection
GTIN (EAN)	4099987023252	
Qty.	20 ST	
Type	CXX V 72	Version
Order No.	3053480000	CUBESERIES, Protective varistor, Rated control voltage: 110...130 V AC, Plug-in connection
GTIN (EAN)	4099987023269	
Qty.	20 ST	
Type	CXX V 73	Version
Order No.	3053490000	CUBESERIES, Protective varistor, Rated control voltage: 220...240 V AC, Plug-in connection
GTIN (EAN)	4099987023276	
Qty.	20 ST	

Accessories

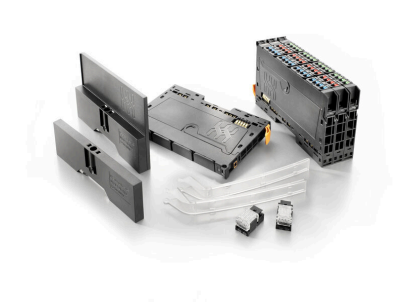

System accessory

Discover a wide range of accessories for your u-remote system - the ideal addition to make your applications even more efficient and flexible.

CSI P 2CO

Weidmüller Interface GmbH & Co. KG
 Klingenbergstraße 26
 D-32758 Detmold
 Germany

www.weidmueller.com

Accessories

General ordering data

Type	UR20-EBK-ACC	Version	
Order No.	1346610000	End bracket, ,	
GTIN (EAN)	4050118151596		
Qty.	5 ST		

white

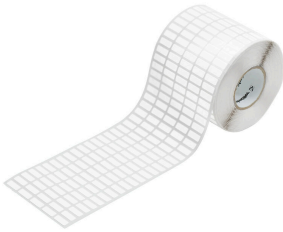

The THM labels offer brilliant printing quality thanks to the thermal transfer technology. Different materials and the user-friendly printing system under Windows optimise every marking effort.

- High-quality polyester labels in various colours or inexpensive paper labels are available
- Labels are automatically positioned in the printer for perfectly centred prints on each label.

General ordering data

Type	THM MT30X 12/6 WS	Version	
Order No.	2466760000	THM, Device markers, 6 x 12 mm, white	
GTIN (EAN)	4050118480887		
Qty.	1 ST		